

Promoción Promoción Promoción Promoción Promoción Promoción Promoción

Brocas Afiladoras Avellanadores Brocas Escalonadas Machos
Fresas Sierras Sierras Oscilantes Discos Coronas Insertos

BLUE-MASTER[®] *by CELESA*

CUTTING TECHNOLOGIES



Promoción Promoción Promoción Promoción Promoción Promoción Promoción

Juegos de Brocas para Metal

Brocas para Metal

Estuches

BC2		Ref.	Uds.	CONTENIDO		
DIN 338	HSS	P6010	19	P Ø1-10x0,50 mm	68,96 €	34,12 €
		P6011	25	P Ø1-13x0,50 mm	143,48 €	70,97 €

BC5		Ref.	Uds.	CONTENIDO		
DIN 338	HSSCo 5%	PC6010	19	P Ø1-10x0,50 mm	115,24 €	57,00 €
		PC6011	25	P Ø1-13x0,50 mm	270,26 €	133,70 €

BC02		Ref.	Uds.	CONTENIDO		
DIN 338	Plus	PP6010	19	P Ø1-10x0,50 mm	77,96 €	38,57 €
		PP6011	25	P Ø1-13x0,50 mm	161,29 €	79,78 €

BC18		Ref.	Uds.	CONTENIDO		
HSS	TIN	PT6010	19	P Ø1-10x0,50 mm	101,79 €	72,53 €
		PT6011	25	P Ø1-13x0,50 mm	222,66 €	158,65 €

BTX		Ref.	Uds.	CONTENIDO		
Ø ≥ 3	HSSCo 5%	PTX010	19	P Ø1-10x0,50 mm	126,40 €	85,32 €
		PTX011	25	P Ø1-13x0,50 mm	278,93 €	187,67 €

TK02		Ref.	Uds.	CONTENIDO		
DIN 338	HSS	TK02010	19	P Ø1-10x0,50 mm	212,27 €	143,28 €
		TK02011	25	P Ø1-13x0,50 mm	378,68 €	255,62 €

BC95		Ref.	Uds.	CONTENIDO		
HSSCo 5%	OX DORADO	PC9510	19	P Ø1-10x0,50 mm	131,37 €	93,60 €
		PC9511	25	P Ø1-13x0,50 mm	296,97 €	211,60 €

TTX		Ref.	Uds.	CONTENIDO		
Ø ≥ 3	HSS	PTTX010	19	P Ø1-10x0,50 mm	113,75 €	76,78 €
		PTTX011	25	P Ø1-13x0,50 mm	250,23 €	168,90 €

TK05		Ref.	Uds.	CONTENIDO		
DIN 338	HSSCo 5%	TK05010	19	P Ø1-10x0,50 mm	265,33 €	179,10 €
		TK05011	25	P Ø1-13x0,50 mm	473,36 €	319,52 €

BC16		Ref.	Uds.	CONTENIDO		
DIN 338	HSS	D16010	19	M Ø1-10x0,50 mm	109,18 €	73,70 €
		D16011	25	M Ø1-13x0,50 mm	239,54 €	161,68 €

BC55		Ref.	Uds.	CONTENIDO		
DIN 338	HSSCo 5%	D55010	18	M Ø1,5-10x0,50 mm	223,10 €	150,60 €
		D55011	24	M Ø1,5-13x0,50 mm	508,03 €	342,92 €



DIN 338

Plástico Azul
Rígido, Robusto y Ligero.
Ventana transparente.
Plástico reforzado con goma antichoque

P Las Referencias que comienzan por "P" se suministran en estuche de plástico.



M Metal Clásico
Caja metálica alta resistencia.



DIN 338



Uds. CONTENIDO
6 Ø 2 - 3 - 4 - 5 - 6 - 8 mm

BC2	DIN 338	HSS	118°			DR9314	20,07 € 9,93 €	
BC5	DIN 338	HSSCo 5%	135°			DC9314	31,90 € 15,78 €	
BC02	DIN 338	Plus	118°			DP9314	21,15 € 10,47 €	
BC18	HSS	TiN	118°			DT9314	21,98 € 15,67 €	
BC95	HSSCo 5%	OX DORADO	130°			DC959314	32,01 € 23,28 €	
BTX	Ø ≥ 3	HSSCo 5%	135°			PTX9314	31,73 € 21,42 €	
TTX	Ø ≥ 3	HSS	135°			PTTX9314	29,55 € 19,95 €	
TK02	DIN 338	HSS	Ø ≥ 4			PTK029314	52,25 € 35,27 €	
TK05	DIN 338	HSSCo 5%	135°			PTK059314	65,31 € 44,08 €	



INOX

INOX



	Ref.	Uds.	CONTENIDO						
BC4	DIN 340	HSSCo 5%	118°		D0004	19 M	Ø1-10x0,50 mm	119,16 € 80,43 €	
BC47	DIN 340	HSSCo 5%	135°		DC004	17 M	Ø2-10x0,50 mm	253,69 € 171,23 €	

DIN 340



	Ref.	Uds.	CONTENIDO						
BC3	DIN 1897	HSS	135°		D3010	17 M	Ø2-10x0,50 mm	80,12 € 54,08 €	
BC31	DIN 1897	HSSCo 5%	135°		D3110	17 M	Ø2-10x0,50 mm	120,12 € 81,08 €	
BC33	DIN 1897	HSSCo 5%	135°		D3310	17 M	Ø2-10x0,50 mm	218,93 € 147,78 €	

INOX

DIN 1897





BC2		Ref.	Uds.	CONTENIDO	
DIN 338	Plus	118°	SET1BC2	91 P Ø1-10x0,10 mm	410,28 € 188,33 €

BC5		Ref.	Uds.	CONTENIDO	
DIN 338	HSSCo 5%	135°	SET1BC5	91 P Ø1-10x0,10 mm	663,76 € 304,67 €

Maletas Metálicas de Brocas Rectificadas

DIN 338	BC2	BC5	BC18
REFERENCIA	BC2880	BC5880	BC18880
Nº BROCAS	125	125	125
CALIDAD	HSS	HSSCo 5%	HSS TiN
CONTENIDO	Ø1-10x0,50 mm	Ø1-10x0,50 mm	Ø1-10x0,50 mm
	439,53 € 201,75 €	727,59 € 333,97 €	603,41 € 407,30 €



REFERENCIA	BC2881	BC5881	BC18881
Nº BROCAS	155	155	155
CALIDAD	HSS	HSSCo 5%	HSS TiN
CONTENIDO	Ø1-10x0,50 mm	Ø1-10x0,50 mm	Ø1-10x0,50 mm
	882,86 € 405,23 €	1.566,70 € 719,12 €	1.229,31 € 829,78 €







DIN 345



	Ref.	Uds.	CONTENIDO	
HSS	MBC11-1	19 M	Ø1-10x0,50 mm	773,06 € 354,83 €
118°	MBC11-2	17 M	Ø2-10x0,50 mm	1.078,50 € 495,03 €







AFB1	
CAPACIDAD AFILADO:	Ø 2,5-19
ÁNGULOS DE PUNTA:	 
TIPOS DE AFILADOS:	 
REAFILA BROCAS:	HSS HSSCo MD TiN PMD
	556,60 € 396,58 €

*Incluye maletín

750X

Alta precisión





AFB2	
CAPACIDAD AFILADO:	Ø 2,5-13
ÁNGULOS DE PUNTA:	 
TIPOS DE AFILADOS:	 
REAFILA BROCAS:	HSS HSSCo MD TiN PMD
	467,54 € 333,12 €

500X

Afilado profesional





AFB3	
CAPACIDAD AFILADO:	Ø 2,5-13
ÁNGULOS DE PUNTA:	
TIPOS DE AFILADOS:	 
REAFILA BROCAS:	HSS HSSCo MD TiN PMD
	225,31 € 160,53 €

XP

Práctico y económico



AFB10	
CAPACIDAD AFILADO:	Ø 3-13
ÁNGULOS DE PUNTA:	
TIPOS DE AFILADOS:	 
REAFILA BROCAS:	HSS HSSCo MD TiN PMD
	302,85 € 215,78 €

*Incluye maletín y muela de repuesto



Ref. AFB10



Avellanadores 3/5 Canales Última Generación

Avellanadores

3/5 Canales

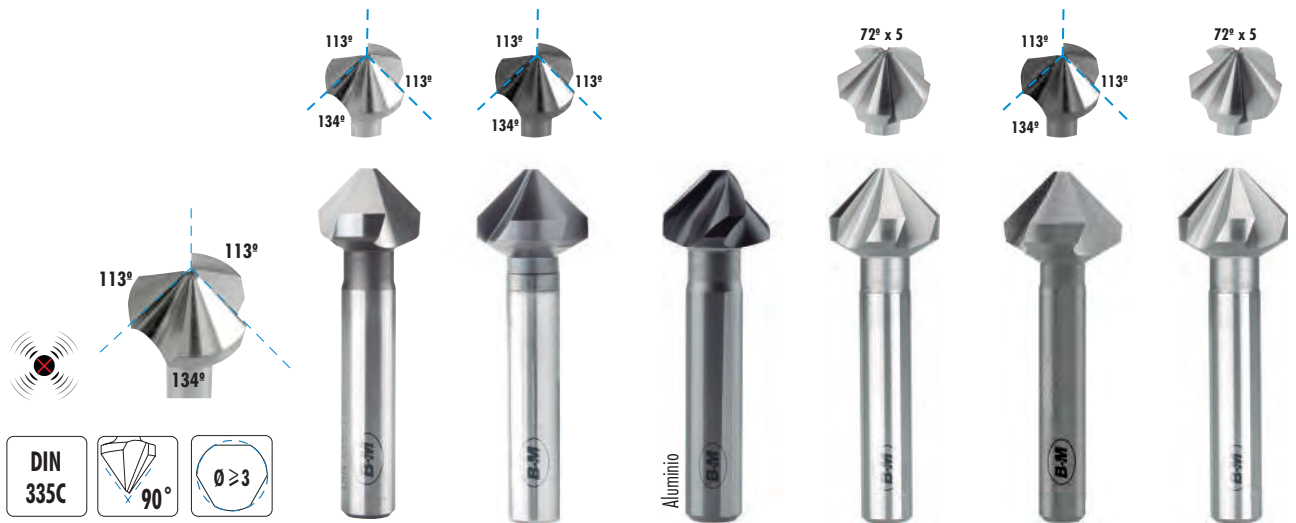

				AV66	AV67	AV99	AV55	AV66MD	AV55MD
MATERIAL				HSSCo	HSSCo	HSSCo	HSSCo	MD	MD
ACABADO					TiAIN	TiAIN			
APLICACIÓN									
				3Z	3Z	3Z	5Z	3Z	5Z
D1 mm	D mín. mm	D2 mm	L1 mm	€	€	€	€	€	€
6,30	1,5	5,0	45	24,03	16,22	31,23	21,08		
8,00	2,0	6,0	50			58,81	39,68		
8,30	2,0	6,0	50	25,88	17,48	33,64	22,72	98,90	66,77
10,00	2,5	6,0	50			64,59	43,60		
10,40	2,5	6,0	50	31,15	21,03	40,50	27,35	107,87	72,82
11,50	2,8	8,0	56			73,35	49,52		
12,40	2,8	8,0	56	33,28	22,47	43,26	29,20	112,48	75,93
14,40	2,4	8,0	56	39,98	26,98	51,97	35,08		
15,00	3,2	10,0	60	46,23	31,20	60,11	40,58		
16,50	3,2	10,0	60	46,71	31,53	60,71	40,98	123,19	83,17
19,00	3,5	10,0	63			117,49	79,30		
20,50	3,5	10,0	63	61,77	41,70	80,30	54,22	170,80	115,28
23,00	3,8	10,0	67			139,26	94,00		
25,00	3,8	10,0	67	84,83	57,25	110,27	74,43	278,71	188,13
31,00	4,2	12,0	71	117,87	79,57	153,23	103,43	314,49	212,28
35,00	4,5	12,0	104	198,34	133,88	257,84	174,05		
40,00	6,5	13,0	112	248,02	167,42	322,41	217,62		
50,00	5,0	16,0	125	380,24	256,67	494,31	333,67		



Avellanadores antivibración de corte variable de nueva generación que mejoran el acabado y aumentan la vida útil. Su diseño con cortes ligeramente asimétricos reduce vibraciones y permite un corte progresivo más eficiente. Además, incorporan tres planos de arrastre que aseguran una sujeción firme en el portabrocas, evitando deslizamientos durante su uso.



Avellanado de HARDOX500 y Materiales de Extrema Dureza.
 Para avellanados en materiales de Alta Dureza y HARDOX500, se recomiendan los avellanadores AV55 y AV55MD de 5Z.
 Modo de Actuación: Es muy importante, en este tipo de materiales, que antes de comenzar a rotar el avellanador para empezar a cortar, la herramienta ya esté en contacto con el material. Posteriormente, comienza a girar e incrementa la velocidad de manera progresiva mientras empieza a penetrar en el material. De esta manera, se evita cualquier choque inicial, donde existe una alta posibilidad de despuntar el filo de corte en la aproximación de la herramienta.



Plástico Azul
Rígido, Robusto y Ligero.
Ventana transparente.
Plástico reforzado con goma antichoque

P



	Ref.	Uds.		CONTENIDO	
HSS	PAV6CM2	6	P	Ø 6,3 - 8,3 - 10,4 12,4 - 16,5 - 20,5 mm	153,07 € 103,32 €
HSSCo	PAV7CM2	6	P	Ø 6,3 - 8,3 - 10,4 12,4 - 16,5 - 20,5 mm	183,82 € 124,08 €



HARDOX 500	Ref.	Uds.		CONTENIDO	
HSSCo	PAV55CM2	6	P	Ø 6,3 - 8,3 - 10,4 12,4 - 16,5 - 20,5 mm	289,65 € 195,52 €



HARDOX 500	Ref.	Uds.		CONTENIDO	
MD	PAV55MDCM2	6	P	Ø 6,3 - 8,3 - 10,4 12,4 - 16,5 - 20,5 mm	875,35 € 590,87 €



MD	Ref.	Uds.		CONTENIDO	
MD	PAV6MDCM2	6	P	Ø 6,3 - 8,3 - 10,4 12,4 - 16,5 - 20,5 mm	627,20 € 423,37 €



Avellanadores antivibración de corte variable de nueva generación que mejoran el acabado y aumentan la vida útil. Su diseño con cortes ligeramente asimétricos reduce vibraciones y permite un corte progresivo más eficiente. Además, incorporan tres planos de arrastre que aseguran una sujeción firme en el portabrocas, evitando deslizamientos durante su uso.

HSSCo	Ref.	Uds.		CONTENIDO	
HSSCo	PAV66CM2	6	P	Ø 6,3 - 8,3 - 10,4 12,4 - 16,5 - 20,5 mm	222,81 € 150,38 €



MD	Ref.	Uds.		CONTENIDO	
MD	PAV66MDCM2	6	P	Ø 6,3 - 8,3 - 10,4 12,4 - 16,5 - 20,5 mm	700,28 € 472,70 €



TiAIN	Ref.	Uds.		CONTENIDO	
HSSCo	PAV67CM2	6	P	Ø 6,3 - 8,3 - 10,4 12,4 - 16,5 - 20,5 mm	289,65 € 195,52 €



Brocas Escalonadas



AV40BM37

AV40BM38

AV40BM36

HSS	Ref.	CAPACIDAD	HSS		TiN	
			€	€	€	€
	AV40BM37	Ø 6 - 15 mm	29,69 €	20,03 €	38,97 €	26,32 €
	AV40BM38	Ø 6 - 20 mm	44,39 €	29,97 €	61,91 €	41,18 €
	AV40BM36	Ø 6 - 30 mm	109,47 €	73,88 €	157,64 €	106,42 €



DIN 13

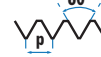

STEP CUT

HSSCo	Ref.	CAPACIDAD	HSS		TiN	
			€	€	€	€
	MTKM03X0,50	M 3x0,50 D	30,18 €	20,37 €		
	MTKM04X0,70	M 4x0,70 D	30,18 €	20,37 €		
	MTKM05X0,80	M 5x0,80 D	31,50 €	21,27 €		
	MTKM06X1,00	M 6x1,00 D	32,81 €	22,13 €		
	MTKM08X1,25	M 8x1,25 D	45,35 €	30,62 €		
	MTKM10X1,50	M 10x1,50 D	54,72 €	36,93 €		
	MTKM12X1,75	M 12x1,75 D	60,31 €	40,72 €		



BMSDS1

BMSDS2

BMSDS3

BMSDS4



AV42BM702B

AV42BM703B

AV42BM704B

HSS	Ref.	CAPACIDAD	HSS		TiN	
			€	€	€	€
	AV40BMSDS1B	Ø 4 - 12 mm	46,18 €	31,17 €	72,88 €	49,20 €
	AV40BMSDS2B	Ø 4 - 12 mm	47,37 €	31,98 €	73,30 €	49,48 €
	AV40BMSDS3B	Ø 4 - 20 mm	60,73 €	41,00 €	93,55 €	63,15 €
	AV40BMSDS4B	Ø 4 - 30 mm	99,63 €	67,25 €	151,87 €	102,52 €

HSS	Ref.	CAPACIDAD	HSS		TiAlN	
			€	€	€	€
	AV42BM702B	Ø 6 - 12 mm	49,17 €	33,20 €	54,62 €	36,87 €
	AV42BM703B	Ø 6 - 20 mm	77,16 €	52,08 €	85,73 €	57,87 €
	AV42BM704B	Ø 6 - 27 mm	101,52 €	68,52 €	112,80 €	76,13 €

Estuches de Brocas Escalonadas



HSS	Ref.	U.	CONTENIDO		€		
			U.	€	€	€	
	PAV40BM234	3	P	AV40BM2 (4-12 mm)	9Z	205,87 €	138,97 €
AV40BM3 (4-20 mm)				9Z			
AV40BM4 (4-30 mm)				14Z			
	PAV40BM235	3	P	AV40BM2 (4-12 mm)	9Z	330,82 €	223,30 €
AV40BM3 (4-20 mm)				9Z			
AV40BM5 (6-38 mm)				12Z			
	PAV40BM2313	3	P	AV40BM2 (4-12 mm)	9Z	413,79 €	279,32 €
AV40BM3 (4-20 mm)				9Z			
AV40BM13 (6-40 mm)				16Z			



BM1

BM2

BM3

BM4

BM5

BM13

Juegos de **Machos y Terrajas** para Roscar a Mano HSS

D624-2		M3 - M4 - M5 - M6 M8 - M10 - M12	Nº 1.1/2	25 x 9	-	30	250,69 € 150,83 €
---------------	---	-------------------------------------	----------	--------	---	----	-------------------------------------



D624

D671-2		M3-M4-M5-M6 M8-M10-M12	25x9 20x7 30x11 38x14	25x9	12	230,90 € 138,92 €
---------------	---	---------------------------	--------------------------	------	----	-------------------------------------



D671

D621-2		M3-M4-M5-M6 M8-M10-M12	2.5/3.3/4.2/5.0 6.8/8.5/10.2 mm	Nº 1 Nº 2	20x5 20x7 25x9 30x11 38x14	TC1	43	406,15 € 244,37 €
---------------	---	---------------------------	------------------------------------	--------------	-------------------------------	-----	----	-------------------------------------





D621

D622-2		M3-M4-M5-M6 M8-M10-M12-M14 M16-M18-M20	2.5/3.3/4.2/5.0 6.8/8.5/10.2 mm	Nº 1 Nº 2	20x5 20x7 25x9 30x11 38x14	TC1	43	744,62 € 448,02 €
---------------	---	--	------------------------------------	--------------	-------------------------------	-----	----	-------------------------------------



JMB2



JMB0

JMB2		M3 - M4 - M5 - M6 M8 - M10 - M12	-	-	-	HSS	218,18 € 131,63 €
JMB0		M3 - M4 - M5 - M6 M8 - M10 - M12	2.5 / 3.3 / 4.2 / 5.0 6.8 / 8.5 / 10.2 mm	-	-	-	249,58 € 150,17 €
JMB1		M3 - M4 - M5 - M6 M8 - M10 - M12	2.5 / 3.3 / 4.2 / 5.0 6.8 / 8.5 / 10.2 mm	Nº 1.1/2	-	-	268,61 € 161,62 €



C5B3		M3 - M4 - M5 - M6 - M8 - M10 - M12	-	-	-	HSS	261,41 € 157,28 €
-------------	---	------------------------------------	---	---	---	-----	-------------------------------------

Machos de Máquina HSSCo en Estuches Metálicos

	FORMA C	FORMA B	 35°	 HSS	HSSCo 5%
JM5	M3-M4-M5-M6 M8-M10-M12	-	-	-	119,64 € 80,77 €
JM6	-	M3-M4-M5-M6 M8-M10-M12	-	-	127,47 € 86,03 €
JM2	-	M3-M4-M5-M6 M8-M10-M12	-	2.5/3.3/4.2/5.0 6.8/8.5/10.2 mm	143,36 € 96,77 €
JM8	-	-	M3-M4-M5-M6 M8-M10-M12	-	161,55 € 109,05 €
JM4	-	-	M3-M4-M5-M6 M8-M10-M12	2.5/3.3/4.2/5.0 6.8/8.5/10.2 mm	187,74 € 126,72 €



Machos y Terrajas

Estuches

Juegos de **Machos de Máquina + Broca Previa**

Machos de Máquina

Estuches



INOX	FORMA B	OX	35°	OX	HSSCo 5%	HSS PM
JMX2	M3-M4-M5-M6 M8-M10-M12	-	-	-	2.5/3.3/4.2/5.0 6.8/8.5/10.2 mm	212,91 € 143,72 €
JMX4	-	M3-M4-M5-M6 M8-M10-M12	-	-	2.5/3.3/4.2/5.0 6.8/8.5/10.2 mm	237,98 € 160,03 €

Plus	FORMA B	BRILLANTE	35°	BRILLANTE	HSSCo 5%	HSS PM
JMP2	M3-M4-M5-M6 M8-M10-M12	-	-	-	2.5/3.3/4.2/5.0 6.8/8.5/10.2 mm	174,20 € 117,58 €
JMP4	-	M3-M4-M5-M6 M8-M10-M12	-	-	2.5/3.3/4.2/5.0 6.8/8.5/10.2 mm	233,10 € 157,35 €

TODO TERRENO	FORMA B	TiN	35°	TiN	HSSCo 5%	HSSCo 5%
JMD2	M3-M4-M5-M6 M8-M10-M12	-	-	-	2.5/3.3/4.2/5.0 6.8/8.5/10.2 mm	280,99 € 189,68 €
JMD4	-	M3-M4-M5-M6 M8-M10-M12	-	-	2.5/3.3/4.2/5.0 6.8/8.5/10.2 mm	311,57 € 210,32 €

1400 N/mm²	FORMA B	TiCN	35°	TiCN	HSSCo 5%	HSS PM
JMC2	M3-M4-M5-M6 M8-M10-M12	-	-	-	2.5/3.3/4.2/5.0 6.8/8.5/10.2 mm	306,51 € 206,90 €
JMC4	-	M3-M4-M5-M6 M8-M10-M12	-	-	2.5/3.3/4.2/5.0 6.8/8.5/10.2 mm	343,15 € 231,63 €

Al	DIENTE ALTERNO	BRILLANTE	2 CANALES	BRILLANTE	HSS	HSSCo 5%
JMAL2	M3-M4-M5-M6 M8-M10-M12	-	-	-	2.5/3.3/4.2/5.0 6.8/8.5/10.2 mm	231,12 € 156,00 €
JMAL4	-	M3-M4-M5-M6 M8-M10-M12	-	-	2.5/3.3/4.2/5.0 6.8/8.5/10.2 mm	229,01 € 154,58 €

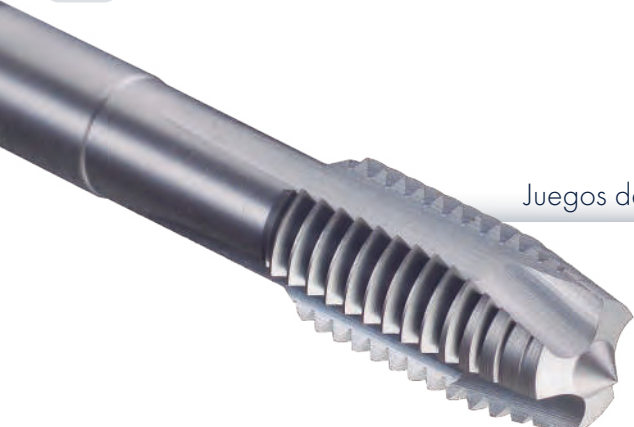

Juegos de **Machos de Máquina**



USO GENERAL	FORMA B	BRILLANTE	35°	BRILLANTE	HSSCo 5%
PT01	M4 - M5 - M6 M8 - M10	M4 - M5 - M6 M8 - M10	-	-	145,42 € 98,17 €

Plus	FORMA B	BRILLANTE	35°	BRILLANTE	HSS PM
PT02	M4 - M5 - M6 M8 - M10	M4 - M5 - M6 M8 - M10	-	-	182,94 € 123,48 €

1400 N/mm²	FORMA B	TiCN	35°	TiCN	HSS PM
PT11	M4 - M5 - M6 M8 - M10	M4 - M5 - M6 M8 - M10	-	-	373,72 € 252,25 €

INOX	FORMA B	OX	35°	OX	HSS PM
PT05	M4 - M5 - M6 M8 - M10	M4 - M5 - M6 M8 - M10	-	-	240,38 € 162,25 €

Al	DIENTE ALTERNO	35°	2 CANALES	HSSCo 5%
PT06	M4 - M5 - M6 M8 - M10	M4 - M5 - M6 M8 - M10	-	228,06 € 153,95 €

Juegos de Fresas de 2 y 4 Labios





2Z					
DIN 327		FF010787	FF020787	FT020787	FF600787
Nº FRESAS		6	6	6	6
TIPO		Ref. FF01	Ref. FF02	Ref. FT02	Ref. FF60
CALIDAD		HSS	HSSCo 8%	TiAlSiN	TiAlN
CONTENIDO Ø mm		4-5-6-8-10-12	4-5-6-8-10-12	4-5-6-8-10-12	4-5-6-8-10-12
		103,34 € 69,75 €	136,67 € 92,25 €	159,37 € 107,58 €	204,56 € 138,08 €



FF010787

FF180787

Acabado





4Z				
DIN 844		FF180787	FT180787	FF200787
Nº FRESAS		6	6	6
TIPO		Ref. FF18	Ref. FT18	Ref. FF20
CALIDAD		HSSCo 8%	TiAlSiN	TiAlN
CONTENIDO Ø mm		4-5-6-8-10-12	4-5-6-8-10-12	4-5-6-8-10-12
		142,72 € 96,33 €	166,43 € 112,33 €	215,63 € 145,55 €



FF010787

FF270847

Desbaste

4Z				
NR		FF250847	FT250847	FF270847
DIN 844				
Nº FRESAS		6	6	6
TIPO		Ref. FF25	Ref. FT25	Ref. FF27
CALIDAD		HSSCo 8%	TiAlSiN	TiAlN
CONTENIDO Ø mm		4-5-6-8-10-12	4-5-6-8-10-12	4-5-6-8-10-12
		379,28 € 256,02 €	442,31 € 298,57 €	456,22 € 307,95 €

Juegos de Extractores de Tornillos y Machos Rotos

	EX/M6K	EX/M8K	EX/M10K	EX/M12K	EX/M14K
Nº PIEZAS	4	4	4	4	4
MÉTRICA	M6	M8	M10	M12	M14
CONTENIDO	K60520-2BR BC310490 EFX/1 • EX/1	K60705-2BR BC310640 EFX/2 • EX/2	K60805-2BR BC310780 EFX/3 • EX/3	K61005-2BR BC310930 EFX/4 • EX/4	K61105-2BR BC311050 EFX/4 • EX/4
	44,05 € 29,73 €	45,86 € 30,97 €	60,39 € 40,77 €	67,99 € 45,90 €	91,52 € 61,77 €



















		Madera Profesional (Corte Preciso)									
PREMIUM	P5562		MADE IN GERMANY CV	TPI 12 2 mm	110 x 132 mm	INOX CUT	30-60 mm	30-60 mm	Blister 5u.: 24,86 €	17,72 €	
	P5547		MADE IN GERMANY CV	TPI 10 2,5 mm	220 x 250 mm	CV	4-200 mm	4-200 mm	Blister 5u.: 57,01 €	40,62 €	
		Madera Profesional (Corte Rápido Y Basto)									
PREMIUM	P5560		MADE IN GERMANY CV	1,7 mm	TPI 6 4 mm	75 x 100 mm	CV	6-60 mm	6-60 mm	Blister 5u.: 11,64 €	8,30 €
	P5568		MADE IN GERMANY CV	1,7 mm	TPI 6 4 mm	130 x 150 mm	CV	5-100 mm	5-100 mm	Blister 5u.: 18,44 €	13,15 €
	P5561		MADE IN GERMANY CV	1,7 mm	TPI 6 4 mm	230 x 250 mm	CV	8-150 mm	8-150 mm	Blister 5u.: 49,00 €	34,92 €
		Madera "Clásico" (Corte Basto)									
	P5506		BLUE-MASTER	TPI 21 1,2 mm	50 x 75 mm	CV	2-15 mm	2-15 mm	Blister 5u.: 6,44 €	4,60 €	
	P5507		BLUE-MASTER	TPI 12 2 mm	50 x 75 mm	CV	4-30 mm	4-30 mm	Blister 5u.: 6,20 €	4,42 €	
	P5508		BLUE-MASTER	TPI 12 2 mm	50 x 75 mm	CV	4-20 mm	4-20 mm	Blister 5u.: 8,93 €	6,37 €	
		Madera Extra Profesional (Corte Rápido Y Preciso)									
	P5541		MADE IN GERMANY Bi-Metall	TPI 12 2 mm	75 x 100 mm	BI	2-30 mm	2-30 mm	Blister 5u.: 22,75 €	16,22 €	
	P5531		MADE IN GERMANY Bi-Metall	TPI 10 2,5 mm	75 x 100 mm	BI	4-30 mm	4-30 mm	Blister 5u.: 23,68 €	16,88 €	
	P5534		MADE IN GERMANY Bi-Metall	TPI 10 2,5 mm	75 x 100 mm	BI	4-30 mm	4-30 mm	Blister 5u.: 18,41 €	13,12 €	
	P5540		MADE IN GERMANY Bi-Metall	TPI 6-12 2-4 mm	110 x 132 mm	BI	3-65 mm	3-65 mm	Blister 5u.: 26,16 €	18,63 €	
		Metal "Clásico"									
	P5514		MADE IN GERMANY HSS	TPI 12 2 mm	50 x 75 mm	HSS	3-6 mm	Al 3-6 mm	Blister 5u.: 10,77 €	7,68 €	
	P5559		MADE IN GERMANY HSS	TPI 8 12/25 mm	75 x 100 mm	HSS	1,5-10 mm	Al 1,5-10 mm	Blister 5u.: 18,45 €	13,15 €	
		Metal Extra Profesional									
	P5537		MADE IN GERMANY Bi-Metall	TPI 8 3 mm	75 x 100 mm	BI	3-15 mm	INOX 3-15 mm Al 3-15 mm	Blister 5u.: 17,55 €	12,52 €	
		Sierras No Dentadas (Goma, caucho, moqueta)									
PREMIUM	P5557		BLUE-MASTER	127 x 152 mm	CV		1-100 mm		Funda 5 uds.: 67,70 €	48,25 €	
	P5558		BLUE-MASTER	75 x 100 mm	CV		1-50 mm		Blister 5u.: 28,69 €	20,43 €	



















Hojas de Sierra de Sable Universales

Madera "Classico Cv"





AG4053		 TPI 3 8,5 mm	 130 x 150 mm	CV	 20-100 mm	 20-100 mm	Funda 5 uds.: 22,73 € 16,20 €
AG4045		 TPI 10 2,5 mm	 210 x 230 mm	CV	 6-180 mm	 6-180 mm	Funda 5 uds.: 86,14 € 61,37 €
AG923		 TPI 7 3,8 mm	 210 x 240 mm	CV	 6-100 mm	 6-100 mm	Funda 5 uds.: 41,54 € 29,60 €







Sierras para reparación de pallets, Packs 100 Unidades

AG916		 TPI 10/14 1,8-2,5 mm	 195 x 215 mm	BI		Pack 100 uds.: 337,97 € 240,82 €
AG917		 TPI 10/14 1,8-2,5 mm	 210 x 230 mm	BI		Pack 100 uds.: 355,59 € 253,37 €
AG918		 TPI 10/14 1,8-2,5 mm	 195 x 215 mm	BI		Pack 100 uds.: 443,77 € 316,20 €
AG919		 TPI 10/14 1,8-2,5 mm	 210 x 230 mm	BI		Pack 100 uds.: 449,65 € 320,37 €

















Tubos, perfiles y chapas de espesor fino y panel sandwich

AG922		 TPI 18 1,4 mm	 210 x 230 mm	BI	 1,5-4 mm	INOX Al 1,5-4 mm 1,5-4 mm	Funda 5 uds.: 43,51 € 31,00 €
--------------	---	---	---	-----------	--	--	--

Tubos, perfiles y chapas de espesor fino y panel sandwich

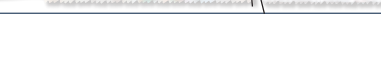
AG920		 TPI 10/14 1,8-2,5 mm	 205 x 225 mm	BI	 2-10 mm	INOX Al 2-10 mm 2-10 mm	64,08 € 45,67 €
--------------	---	--	---	-----------	---	--	-----------------------------------

Tubos y perfiles de espesor grueso

AG924		 TPI 14/18 1,4/1,8 mm	 130 x 150 mm	BI	 1,5-6 mm	INOX Al 1,5-6 mm 1,5-6 mm	Funda 5 uds.: 40,06 € 28,55 €
AG921		 TPI 14/18 1,4/1,8 mm	 205 x 225 mm	BI	 1,5-6 mm	INOX Al 1,5-6 mm 1,5-6 mm	Funda 5 uds.: 37,65 € 26,82 €
AG412		 TPI 10/14 1,8-2,5 mm	 400 x 380 mm	BI	 3-8 mm	INOX Al 2-10 mm 2-10 mm	Funda 2 uds.: 20,14 € 14,35 €
AG413		 TPI 10/14 1,8-2,5 mm	 400 x 380 mm	BI	 3-8 mm	INOX Al 3-8 mm 3-8 mm	Funda 2 uds.: 21,96 € 15,65 €



<p>AG450</p>	<p>Pladur</p>	<p>L 63 mm</p> <p>CV</p> <p><25 mm</p>		<p>Blister 2u.:</p> <p>9,48 € 6,77 €</p>
<p>AG614</p>	<p>Materiales aislantes</p>	<p>205x225 mm</p> <p>CV</p> <p><175 mm</p>		<p>Funda 2 uds.:</p> <p>37,84 € 26,97 €</p>
<p>AG615</p>		<p>280x300 mm</p> <p>CV</p> <p><250 mm</p>		<p>Funda 5 uds.:</p> <p>39,99 € 28,50 €</p>
<p>AG912</p>	<p>Multiuso</p>	<p>TPI 8/10</p> <p>130 x 150 mm</p> <p>BI</p> <p>3-100 mm</p> <p>3-100 mm</p> <p>3-10 mm</p>		<p>Funda 5 uds.:</p> <p>44,26 € 31,53 €</p>

Mango bimaterial para corte con sierra de sable



AG100

- Compartimento para almacenaje de hojas de sierra de recambio. Máximo 6 sierras de hasta 150 mm. (no incluidas)
- Pieza de sujeción metálica para amarre universal 1/2".
- Cambio rápido mediante palanca de fijación.
- Fijación perfecta, sin holgura y de gran resistencia. Excelente ergonomía, mango bimaterial antideslizante.
- Orificio para cordón anticaída.

~~22,86 €~~ **16,30 €**

STARLOCK



Hojas de Sierra Oscilantes

Amarre Starlock

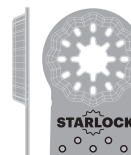

Hojas de Sierra Oscilantes

STARLOCK



Metal

Blister 1 ud.

FTK5204

~~44,46 €~~ **30,02 €**

LONG
Life

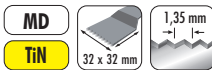

STARLOCK PLUS

FTK5205

~~47,52 €~~ **32,07 €**

LONG
Life

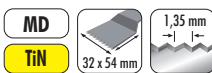

Pack 12 ud.

FTK5106

~~21,39 €~~ **14,45 €** **FTK5106-12** ~~243,77 €~~ **164,55 €**

LONG
Life



50x50x114

FTK5120

~~34,05 €~~ **22,98 €**

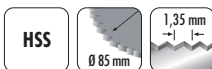

FTK5121

~~35,25 €~~ **23,78 €**



Madera

Blister 1 ud.

FTK5110

~~21,58 €~~ **14,57 €** **FTK5110-12** ~~245,96 €~~ **166,02 €**

Pack 12 ud.

50x50x114

LONG
Life



Pack 12 ud.

FTK5140

~~19,74 €~~ **13,32 €** **FTK5140-12** ~~225,00 €~~ **151,88 €**

50x50x114

HCS



Pack 15 ud.

FTK5117

~~27,67 €~~ **18,68 €** **FTK5117-15** ~~394,25 €~~ **266,12 €**

71x71x114

LONG
Life

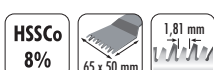

Pack 15 ud.

FTK5147

~~24,82 €~~ **16,75 €** **FTK5147-15** ~~353,69 €~~ **238,73 €**

71x71x114

HCS



STARLOCK



Hojas de Sierra Oscilantes

Amarre Starlock

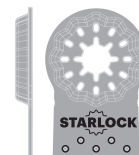

Multifuso

Blister 1 ud.

FTK5111 ~~18,44 €~~ **12,45 €**

LONG
Life



FTK5109 ~~19,90 €~~ **13,43 €**

LONG
Life



FTK5126 ~~22,69 €~~ **15,32 €**

LONG
Life



FTK5132 ~~21,77 €~~ **14,70 €** **FTK5132-12** ~~248,14 €~~ **167,48 €**

LONG
Life



Pack 12 ud.

50x50x114

FTK5108 ~~16,60 €~~ **11,20 €** **FTK5108-12** ~~189,20 €~~ **127,72 €**

LONG
Life



Pack 12 ud.

50x50x114

FTK5130 ~~26,46 €~~ **17,87 €** **FTK5130-15** ~~377,00 €~~ **254,48 €**

LONG
Life

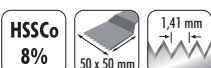

Pack 15 ud.

71x71x114

FTK5129 ~~27,11 €~~ **18,30 €** **FTK5129-15** ~~386,40 €~~ **260,82 €**

LONG
Life

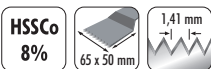

Pack 15 ud.

71x71x114

FTK5113 ~~23,22 €~~ **15,68 €** **FTK5113-15** ~~330,79 €~~ **223,28 €**

CURVED
CUT

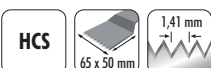

Pack 15 ud.

71x71x114

FTK5127 ~~37,04 €~~ **25,00 €**

HIGH
Precision



STARLOCK



Hojas de Sierra Oscilantes

Amarre Starlock

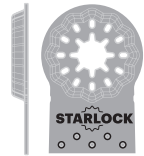

Construcción



Blister 1 ud.

FTK5302

LONG *Life*

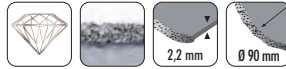

~~92,64 €~~ **62,53 €**

FTK5201

LONG *Life*

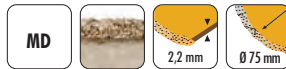

~~42,21 €~~ **28,48 €**

FTK5202

LONG *Life*

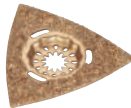

~~41,99 €~~ **28,35 €**

FTK5204

LONG *Life*



~~48,86 €~~ **32,98 €**

STARLOCK PLUS



Rascadores

Blister 1 ud.

FTK5001

LONG *Life*

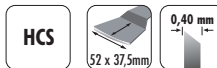

~~16,17 €~~ **10,92 €** FLEXIBLE

FTK5002

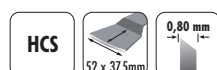

~~16,97 €~~ **11,47 €** RÍGIDA

FTK5003

LONG *Life*



~~17,42 €~~ **11,77 €**

Soporte para lijadoras



FTK5402



~~18,55 €~~ **12,53 €**

Herramientas con **Mango Hexagonal 1/4"**





	BWH9318	BMH9335	BH29335	MAH9327CR
Nº BROCAS	5	5	5	5
TIPO	Ref. BWH	Ref. BMH	Ref. BH2	Ref. MAHM
CALIDAD				
CONTENIDO Ø mm	Ø 3 - 4 - 5 - 6 - 8 mm	Ø 3 - 4 - 5 - 6 - 8 mm	Ø 3 - 4 - 5 - 6 - 8 mm	M4 - M5 - M6 - M8 - M10
	29,19 € 19,72 €	18,12 € 12,23 €	56,87 € 38,38 €	195,42 € 131,92 €



Juegos de Brocas para **Madera de Tres Puntas**

Serie Standard



BM	Ref.	Uds.	CONTENIDO		
	BM9334	5	Ø 4-5-6-8-10 mm	13,56 €	6,72 €
	BM9335	5	Ø 3-4-5-6-8 mm	12,39 €	6,13 €
	BM9333	8	Ø 3-4-5-6-7-8-9-10 mm	22,36 €	11,05 €



Broca Cónica para Cortar Leña



	Ø		
CUSDS3200	32x90	24,07 €	11,05 €
CUSDS4200	42x90	30,83 €	14,15 €
CUSDS5000	50x90	37,75 €	17,33 €



Estuches de Brocas **Serie Standard** para Pared con Punta de Metal Duro













BW1	Ref.	Uds.	CONTENIDO	13,55 €	6,72 €
 	BW19325	4	Ø 4-5-6-8 mm	13,54 €	6,70 €
 	BW19318	5	Ø 3-4-5-6-8 mm	15,05 €	7,45 €
 	BW19327	5	Ø 4-5-6-8-10 mm	15,11 €	7,47 €
 	BW19434	7	Ø 4-5-6-7-8-10-12 mm	28,41 €	13,03 €
 	BW19319	8	Ø 3-4-5-6-7-8-9-10 mm	22,63 €	11,18 €



Serie Standard

Estuches de Brocas **Serie Profesional** para Pared con Punta de Metal Duro











BW6				23,11 €	11,43 €
 	BW69325	4	Ø 4-5-6-8 mm	28,02 €	13,85 €
 	BW69318	5	Ø 3-4-5-6-8 mm	26,85 €	13,28 €
 	BW69327	5	Ø 4-5-6-8-10 mm	30,20 €	14,93 €
 	BW69434	7	Ø 4-5-6-7-8-10-12 mm	49,49 €	22,72 €
 	BW69319	8	Ø 3-4-5-6-7-8-9-10 mm	47,84 €	21,97 €



Serie Profesional

Estuches de Brocas **Serie Extra Profesional** para Hormigón con Punta de Metal Duro



BW16				24,85 €	12,28 €
  	BW169325	4	Ø 4-5-6-8 mm	32,45 €	16,05 €
 	BW169327	5	Ø 5-6-8-10 mm	53,19 €	26,32 €
 	BW169434	7	Ø 4-5-6-7-8-10-12 mm		



Serie Extra Profesional

Estuches de Brocas de **Tres Puntas** para Pared **Delta 3 Plus**



BW35				33,04 €	16,35 €
 	BW359328	4	Ø 5-6-8-10 mm		



Delta 3 plus

Broca de Metal Duro Serie Profesional para Porcelánico, Cerámica y Vidrio

- Trabajar siempre en Rotación
- Refrigerar siempre con agua abundante durante el taladrado.
- Afilado especial punta Metal duro Alto Rendimiento fácil penetración, menor esfuerzo, y mejor calidad de agujero.

APLICACIONES:

- Porcelánico, Cerámica dura, Azulejo, Pizarra, Vidrio, ...

Serie Profesional

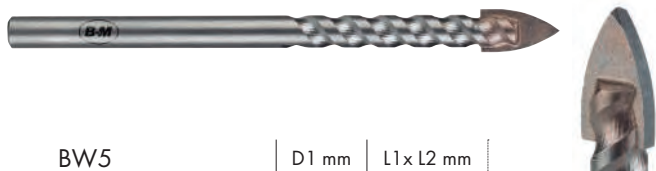
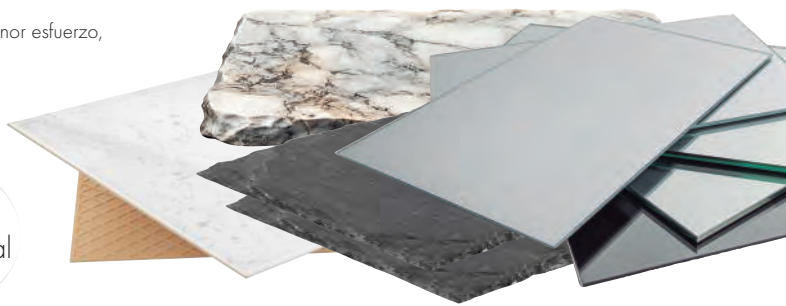

BW5		D1 mm	L1 x L2 mm	7,60 €	3,68 €
★★		BW50300	3,0 80 x 40	7,60 €	3,68 €
★★		BW50400	4,0 80 x 40	7,60 €	3,68 €
★★		BW50500	5,0 80 x 40	7,73 €	3,75 €
		BW50600	6,0 80 x 40	7,73 €	3,75 €
		BW50700	7,0 80 x 40	10,68 €	5,18 €
		BW50800	8,0 100 x 60	12,37 €	6,00 €
		BW50900	9,0 100 x 60	13,09 €	6,35 €
		BW51000	10,0 100 x 60	13,46 €	6,52 €
		BW51200	12,0 100 x 60	27,24 €	13,20 €
		BW51300	13,0 100 x 60	29,62 €	14,35 €



BW5	Ref.	Uds.	CONTENIDO	39,86 €	19,72 €
★★		BW59325	4 Ø 4-5-6-8 mm	39,86 €	19,72 €

Brocas Especiales para Gres, Porcelánico y Pizarra



BW9		Ref.	Uds.	CONTENIDO	125,59 €	57,65 €
★★★★		BW99325	4	Ø 4-5-6-8 mm	125,59 €	57,65 €
★★★★		BW99318	5	Ø 3-4-5-6-8 mm	152,98 €	70,22 €



Serie Extra Profesional



BW7		Ref.	Uds.	CONTENIDO	39,86 €	19,72 €
★★		BW79325	4	Ø 4-5-6-8 mm	39,86 €	19,72 €



Serie Standard



Brocas de Diamante Soldado al Vacío para Porcelánico

Serie Diamond

CAH	D1 mm	Hex	L1xL2 mm	Price	Price
CAH05	5,0	1/4	65 x 30	20,38 €	9,37 €
CAH06	6,0	1/4	65 x 30	21,85 €	10,03 €
CAH07	7,0	1/4	65 x 30	24,88 €	11,42 €
CAH08	8,0	1/4	65 x 30	28,63 €	13,13 €
CAH10	10,0	1/4	65 x 30	30,21 €	13,87 €
CAH12	12,0	1/4	65 x 30	37,27 €	17,10 €
CAH14	14,0	1/4	65 x 30	42,28 €	19,42 €
CAH15	15,0	1/4	65 x 30	64,00 €	29,37 €
CAH16	16,0	1/4	65 x 30	66,73 €	30,63 €
CAH18	18,0	1/4	65 x 30	68,75 €	31,57 €
CAH20	20,0	1/4	65 x 30	70,03 €	32,15 €
CAH22	22,0	1/4	65 x 30	76,98 €	35,33 €
CAH25	25,0	1/4	65 x 30	81,76 €	37,53 €
CAH28	28,0	1/4	65 x 30	82,78 €	38,00 €
CAH30	30,0	1/4	65 x 30	88,91 €	40,82 €
CAH32	32,0	1/4	65 x 30	95,62 €	43,88 €
CAH35	35,0	1/4	65 x 30	103,11 €	47,33 €



Brocas Construcción

Estuches



CPH	D1 mm	Hex	L1xL2 mm	Price	Price
CPH05	6,0	8,5	55 x 25	20,38 €	9,37 €
CPH06	7,0	8,5	55 x 25	21,85 €	10,03 €
CPH08	8,0	8,5	55 x 25	28,63 €	13,13 €
CPH10	10,0	8,5	55 x 25	30,21 €	13,87 €
CPH12	12,0	8,5	55 x 25	37,27 €	17,10 €
CPH14	14,0	8,5	55 x 25	42,28 €	19,42 €

CPH	Ref.	Uds.	CONTENIDO	Price	Price
CPH9328		4	Ø 5-6-8-10 mm	101,08 €	46,40 €

Juego de Brocas de Diamante en Seco



CPS	Ref.	Uds.	CONTENIDO	Price	Price
CPS9328		4	Ø 5-6-8-10 mm	155,72 €	71,48 €

Juego de Brocas M14x2 de Diamante en Seco

M14x2

Especial amoladoras angulares (radiales)

Trabajo en Seco



CSE	Ref.	Uds.	CONTENIDO	Price	Price
CSE9328		6	Ø 5-6-8-10 mm ADCSE PACSE 20 cm3	206,63 €	139,47 €



*Incluye un bote de parafina vegetal

Broca SDS-PLUS 2 Cortes con Doble Canal, Packs 10 y 50 Uds.

W05



Serie Profesional

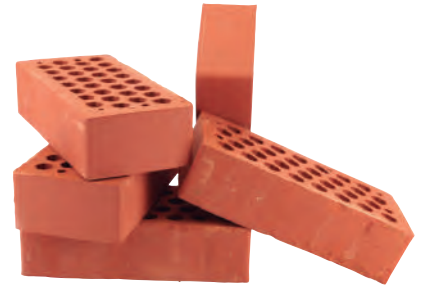

Pack de 10 uds. de brocas W05

Ø mm	L1 x L2 (mm)									
	110x50		160x100		210x150		250x200		300x250	
4,0	69,62	33,73								
5,0	57,11	27,68	72,61	35,18						
6,0	58,74	28,45	67,80	32,85	101,89	49,37	151,19	73,25	208,30	100,92
7,0			82,82	40,12						
8,0	73,86	35,78	74,54	36,12	94,18	45,63	137,03	66,38	209,16	101,33
10,0	79,35	38,45	92,45	44,80	112,19	54,35	141,95	68,78	190,77	92,43
12,0			103,72	50,25	127,60	61,83	157,07	76,10	233,33	113,05
14,0			180,76	87,57	184,13	89,20	205,60	99,60	274,68	133,08
16,0			204,25	98,97	230,45	111,65	253,46	122,80	286,88	139,00



Ej. W0506X110-10

Pack de 50 uds. de brocas W05



Ej. W0506X160-50

Ø mm	L1 x L2 (mm)									
	110x50		160x100		210x150		250x200		300x250	
4,0	328,79	159,30								
5,0	269,67	130,65	342,88	166,12						
6,0	277,40	134,40	320,14	155,10	481,13	233,12	713,96	345,92	983,63	476,57
7,0			391,09	189,48						
8,0	348,80	168,98	351,98	170,53	444,75	215,48	647,11	313,53	987,72	478,55
10,0			436,56	211,52	529,79	256,68	670,30	324,75	900,87	436,48
12,0			489,77	237,30	602,55	291,93	741,70	359,35	1.101,86	533,85
14,0			853,58	413,57	869,48	421,27	970,90	470,42	1.297,09	628,43

Estuches de Brocas SDS-PLUS 2 Cortes con Doble Canal

W05	Ref.	Uds.	CONTENIDO		
	W05D9358	4	Ø 5 - 6 - 8 - 10 x 110 mm	35,91 €	16,48 €
	W05D9412	6	Ø 5 - 6 - 8 x 110 mm Ø 6 - 8 - 10 x 160 mm	54,68 €	25,10 €
	W05D9319	4	Ø 5 - 6 - 8 - 10 x 160 mm	40,16 €	18,43 €
	W05D9320	5	Ø 5 - 6 x 110 mm Ø 6 - 8 - 10 x 160 mm	45,98 €	21,10 €



W05	Ref.	Uds.	CONTENIDO		
	W05D0080	7	Ø 5 - 6 - 8 x 110 mm Ø 6 - 8 - 10 - 12 x 160 mm	67,11 €	30,82 €
	W05D0708	6	Ø 6 x 110 mm Ø 6 - 8 - 10 - 12 - 14 x 160 mm	71,16 €	32,65 €



Broca SDS-PLUS Hormigón Armado Cabeza Integral de Metal Duro 4 Cortes, Packs 10 y 50 Uds.

W77



4Z



Hormigón Armado



Packs de 10 uds. de brocas W77

Ø mm	L1 x L2 (mm)		
	115x50	165x100	215x150
5,0	107,33 52,00	127,74 61,90	
6,0	107,33 52,00	117,15 56,77	199,54 96,68
8,0	139,08 67,38	140,59 68,12	167,80 81,30
10,0	163,26 79,10	165,53 80,20	197,28 95,58
12,0		198,78 96,32	232,80 112,80

Packs 50 uds. de brocas W77

Ø mm	L1 x L2 (mm)	
	165x100	
6,0	566,23 € 274,35 €	
8,0	679,49 € 329,20 €	



W7706X110-10 W7706X160-50

Estuches de Brocas SDS-PLUS Hormigón Armado Cabeza Integral de Metal Duro 4 Cortes

W77	Ref.	Uds.	CONTENIDO		
	W77D9358	4	Ø 5 - 6 - 8 - 10 x 110 mm	63,46 €	29,13 €
	W77D9412	6	Ø 5 - 6 - 8 x 110 mm Ø 6 - 8 - 10 x 160 mm	93,84 €	43,08 €
	W77D9319	4	Ø 5 - 6 - 8 - 10 x 160 mm	67,24 €	30,87 €
	W77D9320	5	Ø 5 - 6 x 110 mm Ø 6 - 8 - 10 x 160 mm	77,91 €	35,77 €



W77	Ref.	Uds.	CONTENIDO		
	W77D0708	7	Ø 5 - 6 - 8 x 110 mm Ø 6 - 8 - 10 - 12 x 160 mm	121,96 €	55,98 €
	W77D008	6	Ø 6 x 110 mm Ø 6 - 8 - 10 - 12 - 14 x 160 mm	116,83 €	53,63 €

Broca Cilindrica Multiuso Serie Profesional



Serie Multiuso Profesional



BW8		D1 mm	L1 x L2 mm	Price	Price
★★	DIN 8039	BW804	4,0 70 x 30	7,96 €	3,67 €
★★		BW805	5,0 85 x 45	8,08 €	3,70 €
		BW806	6,0 100 x 50	9,26 €	4,48 €
		BW807	7,0 100 x 50	10,63 €	4,88 €
		BW808	8,0 120 x 70	11,68 €	5,65 €
		BW809	9,0 120 x 70	13,36 €	6,13 €
		BW810	10,0 120 x 70	17,25 €	7,92 €
		BW812	12,0 150 x 80	18,50 €	8,48 €
		BW806x150	6,0 150 x 50	11,09 €	5,08 €
		BW808X150	8,0 150 x 70	13,23 €	6,08 €
		BW810X150	10,0 150 x 70	19,39 €	8,90 €

BW8		Ref.	Uds.	CONTENIDO	Price	Price
★★	DIN 8039	BW89325	4	Ø 4-5-6-8 mm	40,34 €	18,52 €
★★		BW89328	4	Ø 5-6-8-10 mm	51,66 €	23,72 €
		BW89327	5	Ø 4-5-6-8-10 mm	57,71 €	26,48 €
		BW89434	7	Ø 4-5-6-7-8-10-12 mm	89,36 €	41,02 €

Amplificadores SDS PLUS & SDS MAX

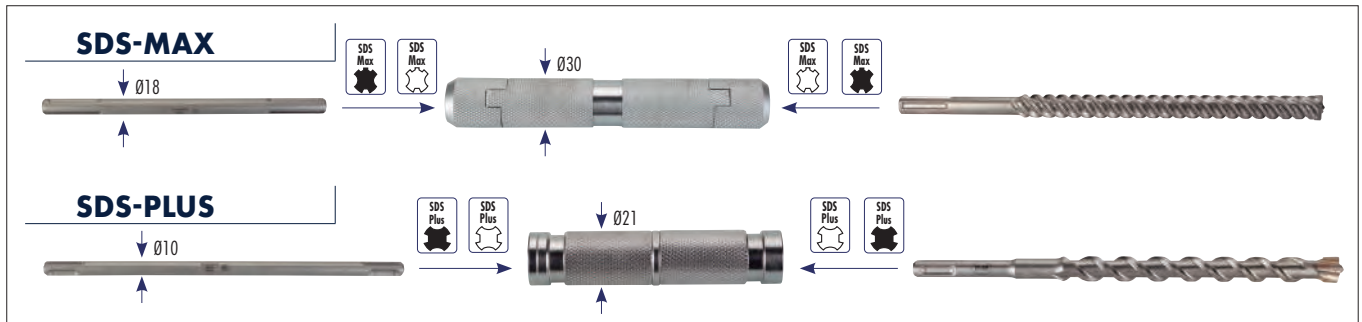

Model	Ø mm	L mm	Description	Price	Price
HMAX	30	-	Conector SDS-MAX	113,79 €	55,13 €
MMA1	18	320	Barra SDS-MAX	27,14 €	13,15 €
MMA2	18	750		60,39 €	29,27 €
MMA3	18	1100		79,30 €	38,43 €

Model	Ø mm	L mm	Description	Price	Price
HPLUS	21	-	Conector SDS-PLUS	95,62 €	46,33 €
MPLUS1	10	250	Barra SDS-PLUS	16,44 €	7,97 €
MPLUS2	10	350		22,77 €	11,03 €
MPLUS3	10	500		28,21 €	13,67 €

Util para Insercion de Picas



Model	ancho mm	long. mm	Price	Price
PI5/8	5/8 = 15,87	250	62,40 €	30,23 €
PI3/4	3/4 = 19,05	250	65,54 €	31,77 €
PI1	1=25,40	250	68,87 €	33,37 €

Model	ancho mm	long. mm	Price	Price
PIPLUS1/2	1/2 = 12,7	170	54,84 €	26,57 €
PIPLUS5/8	5/8 = 15,87	170	57,10 €	27,67 €

Sierras Circulares para Corte en Madera



		Ø mm	Ø Int. mm	e mm	Z		
		160	20	1,8	24	27,46 €	18,53 €
		160	20	2,2	24	27,46 €	18,53 €
		160	20	2,5	24	27,46 €	18,53 €
		160	20	2,5	48	30,99 €	20,92 €
		165	20	2,5	24	32,37 €	21,85 €
		165	20	2,5	48	35,29 €	23,82 €
		184	30	2,5	24	37,84 €	25,55 €
		184	30	2,5	48	45,21 €	30,52 €
		190	30	2,5	24	37,84 €	25,55 €
		190	30	2,5	40	46,25 €	31,22 €
		190	30	2,5	48	48,27 €	32,58 €
		210	30	2,5	48	48,42 €	32,68 €
		235	30	2,5	24	51,63 €	34,85 €
		235	30	2,5	48	55,91 €	37,73 €
		250	30	2,5	60	69,94 €	47,20 €

Sierras Circulares con dientes de acero al carbono para uso con radial



		Ø mm	Ø Int. mm	e mm	Z				
		110	22,23	1,2	3	40	22,82 €	15,40 €	
		110	22,23	1,2	3	60	24,03 €	16,22 €	
		110	22,23	1,2	3	80	24,64 €	16,63 €	
		110	22,23	1,2	3	100	25,85 €	17,45 €	
			125	22,23	1,2	3	40	23,97 €	16,18 €
			125	22,23	1,2	3	60	25,24 €	17,03 €
			125	22,23	1,2	3	80	25,87 €	17,47 €
			125	22,23	1,2	3	100	27,15 €	18,33 €

Discos para Gran Desbaste en Madera para Uso con Radial









DMA115

DMB100

DMC125





	D1 mm	D2 mm	R.P.M.		
	115	22,23	12.500	31,71 €	22,60 €
	100	22,23	12.500	30,81 €	21,95 €
	125	22,23	12.500	34,13 €	24,32 €

Disco para Ranurado y Desbaste en Madera para Uso con Radial

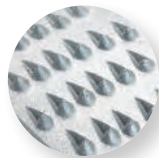

	Ø mm	Ø Int. mm	R.P.M.	30,99 €	20,93 €
HCS	DMR115	115	22,23	12.500	30,99 € 20,93 €
	DMR125	125	22,23	12.500	31,33 € 21,15 €

Discos
Madera

Fresa Ranuradora para Madera para Uso con Radial



	D1 mm	D2 mm	L1 mm	L2 mm	R.P.M.	32,67 €	22,05 €
M14x2	FRDB048X8,5	48	22	85	8,5	12.500	32,67 € 22,05 €

Fresa Esférica para Madera para Uso con Radial

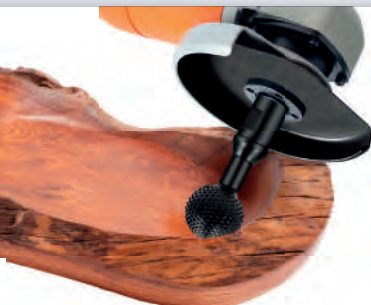

	D1 mm	D2 mm	L1 mm	L2 mm	R.P.M.	29,33 €	19,80 €
M14x2	FEDB030	30	22	85	26	12.500	29,33 € 19,80 €

Fresa Cilíndrica para Desbaste en Madera para Uso con Radial

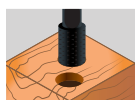

Taladrado

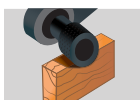

Desbaste

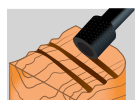

Modelado

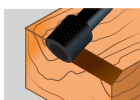

Recanteo



		Ø mm	Ø Int. mm	R.P.M.	23,65 €	15,97 €
M14x2	FDB020	M14x20	20,00	15,00	<20.000	23,65 € 15,97 €
	FDB025	M14x25	25,00	20,00	<20.000	27,10 € 18,30 €
	FDB030	M14x30	29,50	24,00	<20.000	28,28 € 19,10 €

Disco para Tallado y Modelado en Madera, Gran Desbaste



	"	Ø mm	Ø Int. mm	R.P.M.	Z		
DMD115	4,5	115	22,23	12.500	12	33,61 €	22,68 €
DMD125	5	125	22,23	12.500	12	34,67 €	23,40 €



Disco para Gran Desbaste en Madera para Uso con Radial

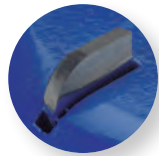

	"	Ø mm	Ø Int. mm	R.P.M.	Z		
DME102Z6	4	102	22,23	11.000	6	47,13 €	31,82 €



Disco para Gran Desbaste en Madera para Uso con Radial



MADERA

	"	Ø mm	Ø Int. mm	R.P.M.	G		
MD							
DD34-115G	4,5	115	22,23	13.300	G	44,87 €	30,28 €
DD34-115M	4,5	115	22,23	13.300	M	44,87 €	30,28 €
DD34-125G	5	125	22,23	12.250	G	48,41 €	32,67 €
DD34-125M	5	125	22,23	12.250	M	48,41 €	32,67 €



Grano M

Grano G

Uso en amoladora.

2 calidades según el trabajo a realizar:

Grano M - Desbaste Medio.

Grano G - Desbaste Grosso.

Disco con Dientes de MD para Corte de Aluminio, Madera y Plástico



MULTIFUNCTION

MD	65 Mn	DD27-125	5	125	22,22	1,2	1	13.300	24	28,22 €	20,12 €
----	-------	----------	---	-----	-------	-----	---	--------	----	--------------------	----------------



Incluye anillo reductor 22,22x20mm - 22,22x16mm



Disco de Diamante Segmentado Soldado al Vacío Multifunción



TOP MULTIFUNCTION

	"	Ø mm	Ø Int. mm	R.P.M.	*H mm	*NºS	e mm				
		SCEP-115	4,5	115	22,23	13.300	4	8	2,2	29,48 €	19,90 €
		SCEP-125	5	125	22,23	12.200	4	9	2,2	34,34 €	23,18 €
		SCEP-230	9	230	22,23	6.600	4	18	3,0	85,62 €	57,80 €
		SCEP-300	12	300	25,40	5.100	5	22	3,2	182,14 €	122,93 €
		SCEP-355	14	355	25,40	4.300	5	26	3,5	222,69 €	150,32 €
		SCEP-400	16	400	25,40	3.800	5	30	3,5	342,16 €	230,95 €



Disco de Corte de Diamante Soldado para todo Tipo de Metales



TOP METAL

		Ø mm	Ø Int. mm	e mm	R.P.M.			
		DD7-105	105	20,00	1,20	15.500	27,42 €	18,52 €
		DD7-115	115	22,23	1,20	13.300	29,48 €	19,90 €
		DD7-125	125	22,23	1,20	12.250	34,34 €	23,18 €
		DD7-180	180	22,23	1,80	8.500	73,17 €	49,40 €
		DD7-230	230	22,23	2,00	6.500	85,62 €	57,80 €
		DD7-300	300	25,40	2,20	5.500	182,14 €	122,93 €
		DD7-355	355	25,40	2,50	5.500	222,69 €	150,32 €
		DD7-400	400	25,40	2,50	5.500	342,16 €	230,95 €



Disco de HSS para Corte de Metales No Ferrosos



METAL

HSS	Z60	DD36-115Z60	4,5	115	1	10.000	15,95 €	10,77 €
		DD36-125Z60	5	125	1	11.000	17,25 €	11,63 €



Disco de Diamante, General de Obra **DIAMOND**

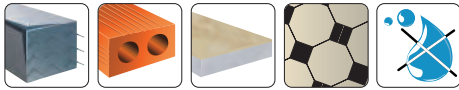

EN13236



Alto Rendimiento



DIAMOND GENERAL DE OBRA

	Ø mm	Ø Int. mm	*H mm	*NºS	e mm	Price	Price
DD1-115	115	22,23	10	9	2,0	10,63€	7,57€
DD1-125	125	22,23	10	9	2,0	12,95€	9,23€
DD1-180	180	22,23	10	14	2,4	30,12€	20,33€
DD1-230	230	22,23	10	18	2,8	44,62€	31,80€
DD1-300	300	25,4/20	10	22	3,0	120,36€	81,23€
DD1-350	350	25,4/20	10	24	3,2	139,15€	93,93€



TOP DIAMOND GENERAL DE OBRA

	Ø mm	Ø Int. mm	*H mm	*NºS	e mm	Price	Price
DD2-115	115	22,23	12	9	1,8	26,20€	17,68€
DD2-125	125	22,23	12	9	2,2	32,91€	21,60€
DD2-180	180	22,23	12	14	2,2	58,52€	39,50€
DD2-230	230	22,23	12	18	2,4	67,00€	45,23€

* H: Altura del perfil de corte * NºS: Número de Segmentos

Disco de Diamante, Alto Rendimiento **TURBO**

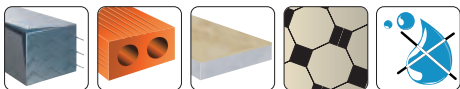

EN13236



Alto Rendimiento



	Ø mm	Ø Int. mm	*H mm	e mm	Price	Price
DD3-115	115	22,23	10	2,0	13,67€	9,73€
DD3-125	125	22,23	10	2,0	16,39€	11,68€
DD3-180	180	22,23	10	2,4	34,84€	23,52€
DD3-230	230	22,23	10	2,8	51,43€	34,72€
DD3-250	250	25,4/20	10	3,0	84,95€	57,35€
DD3-300	300	25,4/20	10	3,2	138,42€	93,43€
DD3-350	350	25,4/20	10	3,2	160,93€	108,02€



TOP TURBO

	Ø mm	Ø Int. mm	*H mm	e mm	Price	Price
DD4-115	115	22,23	12	1,8	23,38€	15,78€
DD4-125	125	22,23	12	2,5	26,81€	18,08€
DD4-180	180	22,23	12	2,5	64,01€	43,20€
DD4-230	230	22,23	12	2,8	72,59€	49,00€

* H: Altura del perfil de corte

Disco de Diamante Continuo, corte húmedo **DIAMOND H₂O**



EN13236



DIAMOND H₂O



	"	Ø mm	Ø Int. mm	R.P.M.	*H mm	e mm	Price	Price
DD5-115	4,5	115	22,23	13.200	10	2,0	8,46€	5,72€
DD5-125	5	125	22,23	12.200	10	2,2	9,91€	6,68€
DD5-180	7	180	22,23	8.400	10	2,4	24,68€	16,67€
DD5-230	9	230	22,23	6.500	10	2,8	34,84€	23,52€

* H: Altura del perfil de corte

* Siempre refrigerar con agua

Disco de Diamante Continuo TOP TILE

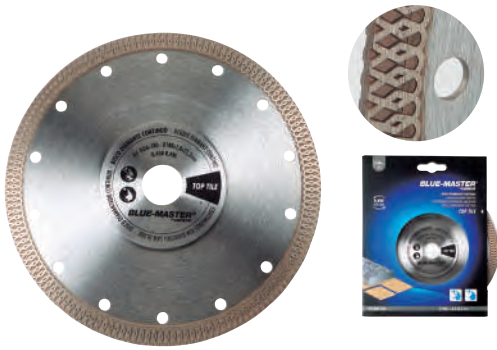

TOP TILE PORCELÁNICO

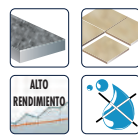

	"	Ø mm	Ø Int. mm	R.P.M.	*H mm	e mm		
DD6-115	4,5	115	22,23	13.200	10	1,5	46,93 €	32,78 €
DD6-125	5	125	22,23	12.200	10	1,5	49,69 €	35,40 €
DD6-180	7	180	22,23	8.400	10	1,8	95,25 €	64,28 €
DD6-230	9	230	22,23	6.500	10	2,0	134,55 €	90,83 €
DD6-250	10	250	22,23	6.100	10	2,8	141,63 €	95,60 €
DD6-300	12	300	25,40	5.100	10	3,2	176,82 €	119,35 €
DD6-350	14	350	25,40	4.400	10	3,2	187,64 €	126,67 €

* H: Altura del perfil de corte

Disco de Diamante, Corte y Biselado a 45°

EN13236



TWIN TILE



	"	Ø mm	Ø Int. mm	R.P.M.	*H mm	e mm		
DD29-125	5	125	22,23	12.250	20/10	1,6	54,92 €	39,12 €

Grano 40-45 /50-60



Disco de Diamante Continuo Corte Preciso XTRACLEAN TILE



XTRACLEAN TILE

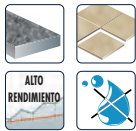

	"	Ø mm	Ø Int. mm	R.P.M.	*H mm	e mm		
DD8-115	4,5	115	22,23	13.200	10	1,4	52,94 €	35,73 €
DD8-125	5	125	22,23	12.200	10	1,4	57,13 €	38,57 €

* H: Altura del perfil de corte

Disco de Diamante para Corte y Desbaste Fino



ALTO RENDIMIENTO

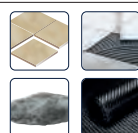

	"	Ø mm	Ø Int. mm	R.P.M.	e mm		
DD35-115	4,5	115	22,2/M14x2	13.200	1,4	79,35 €	53,57 €
DD35-125	5	125	22,2/M14x2	12.200	1,4	91,47 €	61,73 €



Disco de Diamante Segmentado Especial para Piedra

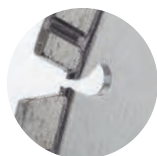

EN13236

CANTERO

	"	Ø mm	Ø Int. mm	R.P.M.	*H mm	*NºS	e mm		
DD9-115	4,5	115	22,23	13.200	10	9	2,0	40,85 €	27,57 €
DD9-125	5	125	22,23	12.200	10	9	2,0	49,69 €	33,53 €
DD9-230	9	230	22,23	6.500	10	18	2,8	120,36 €	81,23 €

* H: Altura del perfil de corte



Disco de Diamante Segmentado Especial para Mármol



EN13236

MARMOLISTA

	"	Ø mm	Ø Int. mm	R.P.M.	*H mm	*NºS	e mm		
DD12-115	4,5	115	22,23	13.200	10	9	2,0	19,40 €	13,10 €
DD12-125	5	125	22,23	12.200	10	9	2,0	21,77 €	14,70 €
DD12-300	12	300	25,4/20	5.100	10	22	3,0	193,57 €	130,67 €
DD12-350	14	350	25,4/20	4.400	10	24	3,2	221,19 €	149,32 €

* H: Altura del perfil de corte



Disco de Diamante Segmentado Especial para Materiales Abrasivos



EN13236

ABRASIVOS

	"	Ø mm	Ø Int. mm	R.P.M.	*H mm	*NºS	e mm		
DD13-350	14	350	25,4/20	4.400	12x22	21	3,2	240,01 €	162,00 €
DD13-400	16	400	25,4/20	4.100	12x22	24	3,4	292,69 €	197,57 €

* H: Altura del perfil de corte

Disco de Diamante Segmentado Especial Asfalto



EN13236

ASPHALT

	"	Ø mm	Ø Int. mm	R.P.M.	*H mm	*NºS	e mm		
DD14-300	12	300	25,4/20	5.100	12x22	18	3,0	240,51 €	162,35 €
DD14-350	14	350	25,4/20	4.400	12x22	21	3,2	295,49 €	199,45 €
DD14-400	16	400	25,4/20	4.100	12x22	24	3,4	364,21 €	245,83 €

* H: Altura del perfil de corte

Disco de Diamante Segmentado Especial Hormigón



CONCRETE



	"	Ø mm	Ø Int. mm	R.P.M.	*H mm	*NºS	e mm		
DD15-115	4,5	115	22,23	13.200	15	9	2,5	28,50 €	20,32 €
DD15-125	5	125	22,23	12.200	15	9	2,5	32,58 €	21,98 €
DD15-230	9	230	22,23	6.600	15	18	2,8	46,33 €	33,02 €
DD15-300	12	300	25,4/20	5.100	15	22	3,2	158,82 €	107,20 €
DD15-350	14	350	25,4/20	4.400	15	24	3,4	199,53 €	134,68 €

* H: Altura del perfil de corte

Discos de Diamante Segmentado Especial para Rozadora



TOP WALL



	"	Ø mm	Ø Int. mm	R.P.M.	*H mm	*NºS	e mm		
DR-115	4,5	115	22,2	13.300	10	8	6,4	82,92 €	55,37 €
DR-125	5	125	22,2	12.200	10	9	6,4	90,95 €	60,78 €
DR-150	6	150	22,2	10.000	10	12	6,4	107,16 €	72,33 €

* H: Altura del perfil de corte · * N°S: Número de Segmentos

Discos de Diamante para Corte y Desbaste Fino

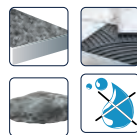

	"	Ø mm	Ø Int. mm	Grano	e mm		
DD39-125X1,4-F	5	125	22,23	50-60	6,4	51,58 €	34,82 €
DD39-125X1,4-M	5	125	22,23	40-50	6,4	51,58 €	34,82 €
DD39-125X1,4-G	5	125	22,23	35-40	6,4	51,58 €	34,82 €

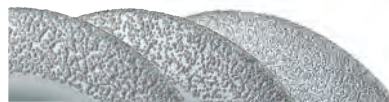

Discos Abrasivo Grano Metal Duro



MULTIFUNCTION

	"	Ø mm	Ø Int. mm	R.P.M.		
MD	4,5	115	22,23	13.200	17,08 €	12,18 €



Grano abrasivo de Metal duro.
Calidad Extra fuerte.



Plato Segmentado de **Diamante**



UNIVERSAL STONE

	"	Ø mm	Ø Int. mm	R.P.M.	*NºS		
	DD10-115	4,5	115	22,23	13.200	16	53,92 € 37,78 €
	DD10-125	5	125	22,23	12.250	20	58,96 € 41,37 €
	DD10-180	7	180	22,23	8.400	28	107,29 € 72,42 €

* NºS: Número de segmentos



TOP STONE

	"	Ø mm	Ø Int. mm	R.P.M.	*NºS		
	DD11-115	4,5	115	22,23	13.200	16	74,47 € 50,27 €
	DD11-125	5	125	22,23	12.250	20	80,77 € 54,53 €
	DD11-180	7	180	22,23	8.400	28	140,11 € 94,58 €

* NºS: Número de segmentos



TOP STONE THREAD

	"	Ø mm	Ø Int. mm	R.P.M.	*NºS		
	DD20-115	4,5	115	M14x2	5.100	18	74,47 € 50,27 €
	DD20-125	5	125	M14x2	4.400	20	80,77 € 54,53 €

* NºS: Número de segmentos

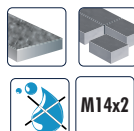

M14x2



*Rosca directa a radial M14x2

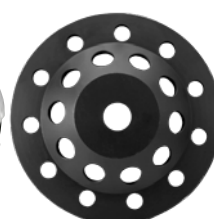

BOOMERANG

	"	Ø mm	Ø Int. mm	R.P.M.	*NºS		
	DD40-115	4,5	115	22,23	13.200	6	74,47 € 50,27 €
	DD40-125	5	125	22,23	12.250	7	80,77 € 54,53 €
	DD40-180	7	180	22,23	8.400	11	140,11 € 94,58 €
	DD40-230	9	230	22,23	6.600	14	158,41 € 106,92 €

* NºS: Número de segmentos

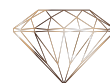

Soporte Cuerpo Lijador



VELCRO



	"	Ø mm					
	DD25-100	4	100	12.500	1	14,73 € 9,95 €	
	DD25-115	4,5	115	12.500	1	17,55 € 11,85 €	
	DD25-125	5	125	12.500	1	18,24 € 12,32 €	

Plato con velcro para lijado y pulido de superficies. Rosca M14x2 integrada.
Apto para trabajo con todo tipo de accesorios de lija, fieltro, lana BLUEMASTER.
Para accesorios con velcro: DD26 · DD28 · DD31 · DD32 · DD33
Uso en amoladora.

Multilija con Cambio Rápido CDR

- Cambio rápido de disco, sencillo y preciso. Sin herramientas adicionales.
- Centrado perfecto de disco sobre el soporte
- Excelente para alto rendimiento y grandes volúmenes de rectificado.
- Perfecto para rectificar, pulir, desbarbar, limpiar, abrillantar, todo tipo de materiales.
- Indicado para utilizar en máquinas neumáticas o eléctricas.

	Ø mm			
CDR 	RLOC25	25	1	13,63 € 9,20 €
	RLOC50	50	1	13,63 € 9,20 €
	RLOC75	75	1	16,68 € 11,27 €

*Compatible con sistemas Roloc™, Lockit, Speed Lock Tr, Power Lock Typ III, FastLock B, Roll-On.



ALOX
Lijado y pulido en aplicaciones generales Metal.

	Ø mm	Grano			
	RLOC1-25P60	25	60	50	0,76 € 0,52 €
	RLOC1-25P120	25	120	50	0,76 € 0,52 €
	RLOC1-50P40	50	40	50	1,14 € 0,77 €
	RLOC1-50P60	50	60	50	1,14 € 0,77 €
	RLOC1-50P80	50	80	50	1,14 € 0,77 €
	RLOC1-50P120	50	120	50	1,14 € 0,77 €
	RLOC1-75P40	75	40	50	1,33 € 0,90 €
	RLOC1-75P60	75	60	50	1,33 € 0,90 €
	RLOC1-75P120	75	120	50	1,33 € 0,90 €

ALOX Plus
Lijado y pulido. Alto rendimiento en metal, Inox.

	Ø mm	Grano			
	RLOC2-25P60	25	60	50	0,95 € 0,65 €
	RLOC2-25P120	25	120	50	0,95 € 0,65 €
	RLOC2-50P36	50	36	50	1,42 € 0,97 €
	RLOC2-50P60	50	60	50	1,42 € 0,97 €
	RLOC2-50P80	50	80	50	1,42 € 0,97 €
	RLOC2-50P120	50	120	50	1,42 € 0,97 €
	RLOC2-75P36	75	36	50	1,67 € 1,13 €
	RLOC2-75P60	75	60	50	1,67 € 1,13 €
	RLOC2-75P80	75	80	50	1,67 € 1,13 €
	RLOC2-75P120	75	120	50	1,67 € 1,13 €

CIRCONIO
Lijado y pulido. Inox, Acero, Fundición, Aluminio

	Ø mm	Grano			
	RLOC3-25P60	25	60	50	0,83 € 0,55 €
	RLOC3-25P120	25	120	50	0,83 € 0,55 €
	RLOC3-50P40	50	40	50	1,21 € 0,82 €
	RLOC3-50P60	50	60	50	1,21 € 0,82 €
	RLOC3-75P40	75	40	50	1,52 € 1,02 €
	RLOC3-75P60	75	60	50	1,52 € 1,02 €
RLOC3-75P120	75	120	50	1,52 € 1,02 €	

CERAMIC
Lijado y pulido. Acero y Aleaciones

	Ø mm	Grano			
	RLOC4-50P40	50	40	50	1,46 € 0,98 €
	RLOC4-50P60	50	60	50	1,46 € 0,98 €
	RLOC4-50P80	50	80	50	1,46 € 0,98 €
	RLOC4-75P40	75	40	50	1,90 € 1,28 €
	RLOC4-75P60	75	60	50	1,90 € 1,28 €
	*RLOC5-75P40	75	40	50	2,26 € 1,53 €
	*RLOC5-75P60	75	60	50	2,26 € 1,53 €

*Alto Rendimiento

CONDITIONING
Acondicionado de superficies, previo a pintado.

	Ø mm	Grano			
	RLOC6-50P1	50	Basto	25	1,31 € 0,88 €
	RLOC6-50P2	50	Medio	25	1,31 € 0,88 €
	RLOC6-75P1	75	Basto	25	1,90 € 1,28 €
	RLOC6-75P2	75	Medio	25	1,90 € 1,28 €

C-STRIP
Limpieza de todo tipo de superficies

	Ø mm			
	RLOC7-50	50	10	3,71 € 2,50 €
	RLOC7-75	75	10	4,73 € 3,20 €

UNITIZED
Pulido y abrillantado fino.



	Ø mm			
	RLOC8-50	50	10	7,73 € 5,22 €
	RLOC8-75	75	10	13,82 € 9,33 €

Nuevo Sistema para Taladrado Profesional Modular Drilling

Serie
Modular
Drilling

SM



TALADRE, fácilmente hasta profundidades de 3 metros, en diámetros de 26mm a 150mm
 AÑADA, El número de extensiones que considere hasta obtener la longitud de taladrado necesaria.
 COMBINE, Husillo SDS MAX con Extensiones, brocas, cabeza rompedora y coronas para conseguir perforar profundidades extremadamente largas, e inaccesibles.
 LONGITUD MÁXIMA RECOMENDADA, 3 METROS.

3.000 mm
Capacidad
de corte

Combine husillos, alargadores y puntas de broca ó corona,
y genere herramientas especiales de gran longitud.

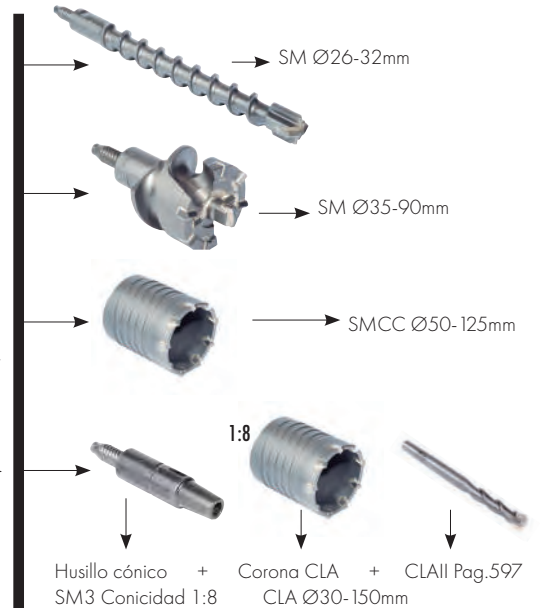
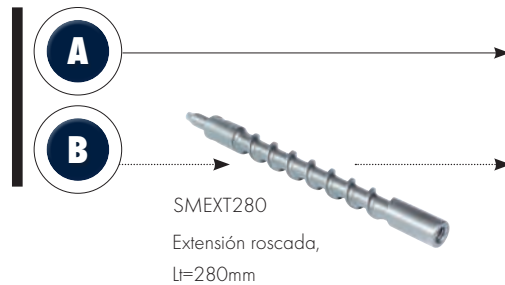

Ejemplos de combinaciones disponibles:

Combinación para broca de hormigón de 4 cortes extensible, ø 26-32 mm



Combinación para cabeza rompedora extensible, ø 35-90 mm

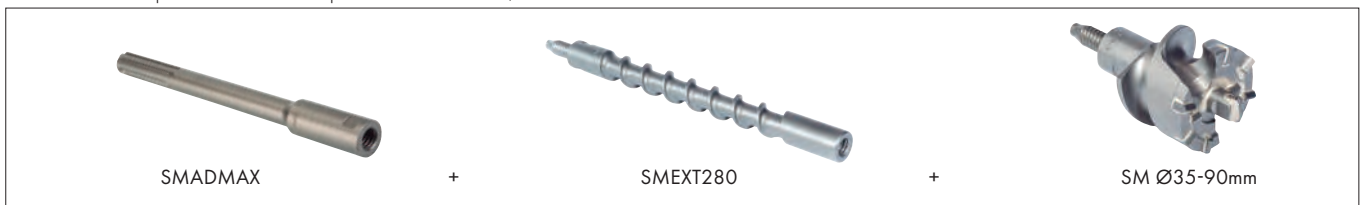

Combinación para corona extensible, ø 50-125 mm

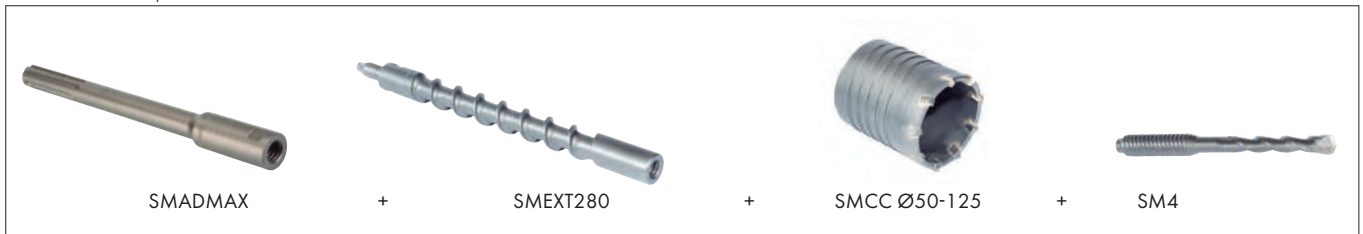

Combinación para corona cla amarre cónico 1:8, extensible ø 30-150 mm





Nuevo Sistema para Taladrado Profesional Modular Drilling

Para taladrado de profundidades superiores a 720 mm, aconsejamos el uso de una broca previa igual a la mitad de la medida final, como mínimo, para evitar la rotura.

SM



Husillo SDS Max Roscado



	L1 mm	SMADMAX	
SMADMAX250	250	150,01 €	68,85 €
SMADMAX450	450	246,17 €	113,00 €
SMADMAX850	850	453,87 €	208,32 €



Extensión Roscada



	L1 mm	D1 mm	SMEXT	
SMEXT280	280	25	194,25 €	89,17 €

Incluye 1 tornillo de unión SM2 incorporado.

Broca Hormigón 4 Cortes Roscada



	D1 mm	L1 mm	SM	
SM26	26	250	294,40 €	135,13 €
SM28	28	450	314,41 €	144,32 €
SM30	30	850	334,41 €	153,50 €
SM32	32	850	354,41 €	162,68 €

Incluye 1 tornillo de unión SM2 incorporado.

Broca Hormigón 4 Cortes Roscada

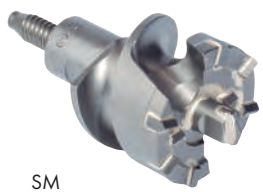

	D1 mm	SM	
SM35	35	499,19 €	229,13 €
SM40	40	552,27 €	253,48 €
SM45	45	608,04 €	279,08 €
SM50	50	631,96 €	290,07 €
SM55	55	658,50 €	302,25 €
SM60	60	698,36 €	320,55 €
SM68	68	738,13 €	338,80 €
SM80	80	854,98 €	392,43 €
SM90	90	1.077,99 €	494,78 €

Incluye 1 tornillo de unión SM2 incorporado.

Broca Hormigón 4 Cortes Roscada



	D1 mm	Z	SM	
SMCC50	50	7	279,01 €	128,07 €
SMCC65	65	8	353,56 €	162,28 €
SMCC80	80	9	412,10 €	189,15 €
SMCC90	90	10	461,57 €	211,87 €
SMCC105	105	11	629,04 €	288,73 €
SMCC125	125	12	690,28 €	316,85 €

Incluye 1 tornillo de unión SM2 incorporado.



	D1 mm	L1 mm	SM	
Tornillo de unión	SM2	14	62	23,85 € 10,95 €
Husillo roscado para corona CLA 1:8	SM3*	26	90	140,71 € 64,58 €
Broca guía roscada	SM4*	11	150	72,70 € 33,38 €

Incluye 1 tornillo de unión SM2 incorporado.



35 mm
Capacidad
de Corte



CB

HSS M3	4/6		Al
Cu-Ni-La	FUNDICIÓN		PVC



CB9576



Maletines de Coronas para Electricistas

10
Piezas

Ref.	CONTENIDO		
CB9576	Ø 16-20-25-32-40-50-68 mm	142,57 €	85,55 €
CB9570	Ø 20-25-32-40-44-60-68 mm	145,41 €	87,23 €

Contenido:

- 1 Husillo Ref. 5519 9,5 Capacidad 14-30
- 1 Husillo Ref. 5546 9,5 Capacidad 32-250
- 1 Adaptador husillo Ref. 5511



Maletines de Coronas para Cerrajeros

9
Piezas

Ref.	CONTENIDO		
CB9571	Ø 22-35-51-60-68-73 mm	151,37 €	90,83 €
CB9574	Ø 22-35-50-60-68-73 mm	151,37 €	90,83 €

Contenido:

- 1 Husillo Ref. 5519 9,5 Capacidad 14-30
- 1 Husillo Ref. 5546 9,5 Capacidad 32-250
- 1 Adaptador husillo Ref. 5511

Maletines de Coronas para Fontaneros

10
Piezas

Ref.	CONTENIDO		
CB9573	Ø 20-25-30-40-44-60-68 mm	145,41 €	87,23 €
CB9575	Ø 19-25-32-40-44-60-68 mm	145,41 €	87,23 €

Contenido:

- 1 Husillo Ref. 5519 9,5 Capacidad 14-30
- 1 Husillo Ref. 5546 9,5 Capacidad 32-250
- 1 Adaptador husillo Ref. 5511



Maletín para Mantenimiento Industrial

13
Piezas

Ref.	CONTENIDO		
CB9572	Ø 20-22-25-32-35-40-44-60-68-76 mm	183,27 €	109,97 €

Contenido:

- 1 Husillo Ref. 5519 9,5 Capacidad 14-30
- 1 Husillo Ref. 5546 9,5 Capacidad 32-250
- 1 Adaptador husillo Ref. 5511

- Mayor duración afilado y corte.
- Cortes más rápidos y precisos.
- Menor vibración y desgaste.
- M42. Mayor dureza y rendimiento.

45 mm
Capacidad de Corte



COB



COB9576



Maletines de Coronas para Electricistas

10
Piezas

Ref.	CONTENIDO	153,58 €	92,15 €
COB9576	Ø 16-20-25-32-40-50-68 mm		
COB9570	Ø 20-25-32-40-44-60-68 mm	159,94 €	95,97 €

Contenido:

- 1 Husillo Ref. 5519 9,5 Capacidad 14-30
- 1 Husillo Ref. 5546 9,5 Capacidad 32-250
- 1 Adaptador husillo Ref. 5511



Maletines de Coronas para Cerrajeros

9
Piezas

Ref.	CONTENIDO	166,51 €	99,90 €
COB9571	Ø 22-35-51-60-68-73 mm		
COB9574	Ø 22-35-50-60-68-73 mm	166,51 €	99,90 €

Contenido:

- 1 Husillo Ref. 5519 9,5 Capacidad 14-30
- 1 Husillo Ref. 5546 9,5 Capacidad 32-250
- 1 Adaptador husillo Ref. 5511

Maletines de Coronas para Fontaneros

10
Piezas

Ref.	CONTENIDO	159,94 €	95,97 €
COB9573	Ø 20-25-30-40-44-60-68 mm		
COB9575	Ø 19-25-32-40-44-60-68 mm	159,94 €	95,97 €

Contenido:

- 1 Husillo Ref. 5519 9,5 Capacidad 14-30
- 1 Husillo Ref. 5546 9,5 Capacidad 32-250
- 1 Adaptador husillo Ref. 5511



Maletín para Mantenimiento Industrial

13
Piezas

Ref.	CONTENIDO	201,59 €	120,97 €
COB9572	Ø 20-22-25-32-35-40-44-60-68-76 mm		

Contenido:

- 1 Husillo Ref. 5519 9,5 Capacidad 14-30
- 1 Husillo Ref. 5546 9,5 Capacidad 32-250
- 1 Adaptador husillo Ref. 5511

Estuches con Coronas para **Taladro con Base Electromagnética**

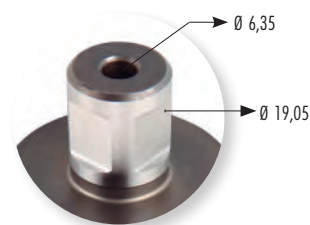

	Ref.	CONTENIDO	
HSS	EFB250R1	6 Coronas Ref. 250R: Ø 12 - 14 - 16 - 18 - 20 - 22 mm 2 Punzones Ref. P250CA	354,26 € 239,13 €
HSSCo	EFB250C1	6 Coronas Ref. 250C: Ø 12 - 14 - 16 - 18 - 20 - 22 mm 2 Punzones Ref. P250CA	494,92 € 334,07 €



	Ref.	CONTENIDO	
HSS	EFB500R1	6 Coronas Ref. 500R: Ø 12 - 14 - 16 - 18 - 20 - 22 mm 2 Punzones Ref. P500CA	529,90 € 357,68 €
HSSCo	EFB500C1	6 Coronas Ref. 500C: Ø 12 - 14 - 16 - 18 - 20 - 22 mm 2 Punzones Ref. P500CA	705,54 € 476,23 €
HSS	EFB500R5	6 Coronas Ref. 500R: Ø 14 - 16 - 18 - 20 - 22 - 24 mm 2 Punzones Ref. P500CA	545,68 € 368,33 €
HSSCo	EFB500C5	6 Coronas Ref. 500C: Ø 14 - 16 - 18 - 20 - 22 - 24 mm 2 Punzones Ref. P500CA	751,18 € 507,05 €

	Ref.	CONTENIDO	
HSS	EFBBMG1	6 Coronas Ref. BMG: Ø 6 - 8 - 10 - 12 - 14 - 16 mm	290,88 € 196,35 €
HSS	EFBBMG2	3 Coronas Ref. BMG: Ø 6 - 8 - 10 mm 3 Coronas Ref. 250R: Ø 12 - 14 - 16 mm 2 Punzones Ref. P250CA	313,02 € 211,28 €
HSSCo	EFBBMG3	3 Coronas Ref. BMG: Ø 6 - 8 - 10 mm 3 Coronas Ref. 250C: Ø 12 - 14 - 16 mm 2 Punzones Ref. P250CA	380,20 € 256,63 €



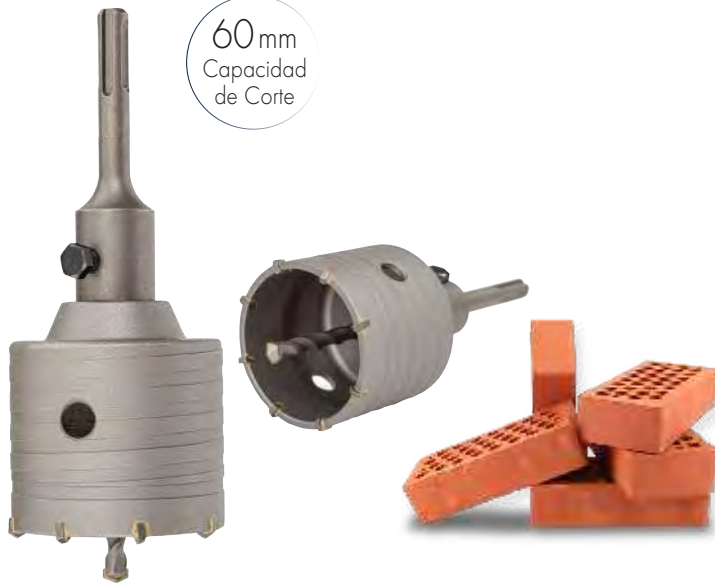

60mm
Capacidad de Corte

MDSDS



	Ø mm	DESCRIPCIÓN		
MD50SDSB	50	Mango SDS PLUS M16 L: 110mm	80,64 €	54,43 €
MD60SDSB	60		92,41 €	62,37 €
MD68SDSB	68		94,55 €	63,83 €
MD90SDSB	90		139,49 €	94,15 €

Ø 50,60 y 68 mm instaladores aire acondicionado
Ø 90 mm instaladores caldera Pellets

Corona Pesada para Construcción, **Dientes de Metal Duro**, Sujeción Cónica 1:8 Anti-Rotura

Corona pesada para alto rendimiento en martillos eléctricos con potencia de impacto mayor de ≥ 900w.

Dientes de metal duro inclinados en perfecta posición para un potente ataque. Husillo y corona tratados térmicamente para una mayor resistencia y rendimiento.

Amarre cónico 1:8 hace mas solidaria la unión husillo-corona y mejora la transmisión de potencia.

70mm
Capacidad de Corte

CLA



Husillos Con Mango Sds Max



Amarre Cónico 1:8

Amarre Cónico 1:8

	DESCRIPCIÓN		
CLAMAX220	Mango SDS MAX. Lt:220 mm	80,83 €	54,55 €
CLAMAX420	Mango SDS MAX. Lt:420 mm	95,25 €	64,28 €
CLAMAX700	Mango SDS MAX. Lt:700 mm	155,89 €	105,23 €
CLAMAX900	Mango SDS MAX. Lt:900 mm	212,25 €	143,27 €

* Consulte la gama de husillos con mango estriado y mango hexagonal 13 mm disponibles.



	Ø mm	CLA	
CLA030	30	138,45 €	93,45 €
CLA035	35	144,84 €	97,77 €
CLA040	40	148,71 €	100,38 €
CLA045	45	160,89 €	108,60 €
CLA050	50	173,71 €	117,25 €
CLA055	55	187,98 €	126,88 €
CLA060	60	191,92 €	129,53 €
CLA066	66	193,94 €	130,90 €
CLA068	68	199,39 €	134,60 €
CLA070	70	237,78 €	160,50 €
CLA080	80	262,61 €	177,25 €
CLA090	90	303,30 €	204,73 €
CLA100	100	327,70 €	221,20 €
CLA110	110	358,84 €	242,22 €
CLA115	115	373,98 €	251,83 €
CLA125	125	387,74 €	261,72 €
CLA150	150	501,90 €	338,78 €

* El precio no incluye husillo, ni broca guía.

Kit Extracción para Corona CLA y PM



CLAEX ~~45,33 €~~ **30,60 €**

Brocas Guía Coronas CLA y PM Ø11x130 mm



CLA11 ~~16,91 €~~ **11,42 €**

Corona de Diamante Segmentada

Husillos Con Mango SDS Max

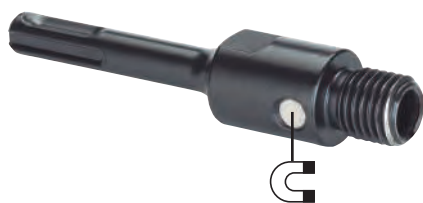

M16x2

60 mm
Capacidad
de Corte



M16x2



	DESCRIPCIÓN		
CDDHEX	Husillo Mango Hex. 10,8 mm Lt:120 mm	21,79 €	14,72 €
CDDMAX	Husillo Mango SDS Max Lt:200 mm	27,14 €	18,32 €
CDDPLUS	Husillo Mango SDS Plus Lt:200 mm	23,66 €	15,98 €

Broca Guía SDS Plus



W0505x110

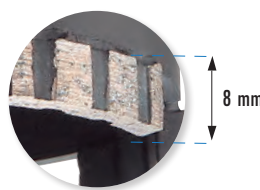

	Ø mm	Z		
CDD08	8	Circular	50,60 €	34,15 €
CDD10	10	Circular	55,12 €	37,20 €
CDD12	12	Circular	64,45 €	43,50 €
CDD15	15	Circular	69,94 €	47,20 €
CDD20	20	Circular	79,77 €	53,85 €
CDD26	26	Circular	86,94 €	58,68 €
CDD30	30	4	102,04 €	68,88 €
CDD35	35	4	110,60 €	74,65 €
CDD40	40	4	114,12 €	77,03 €
CDD45	45	4	118,36 €	79,88 €
CDD52	52	4	123,29 €	83,22 €
CDD55	55	4	128,75 €	86,92 €
CDD68	68	5	152,33 €	102,83 €
CDD72	72	5	155,42 €	104,92 €
CDD82	82	6	162,80 €	109,88 €
CDD92	92	8	174,36 €	117,68 €
CDD102	102	8	188,20 €	127,03 €

Juegos de Corona de Tungsteno para Materiales No Metálicos

ACABADOS MUY FINOS
• Excelente comportamiento
en aglomerado y madera.

30 mm
Capacidad
de Corte



MG



MG9573



MG9572

Estuche Coronas Master-Grit

6

Piezas

Ref.	CONTENIDO		
MG9571	22 - 35 - 51 - 60 - 64 - 70 mm	197,23 €	133,13 €

Contenido

- 1 Husillo Ref. B5519-CM ϕ 9,5 Capacidad 14-30
- 1 Husillo Ref. B5546-CM ϕ 9,5 Capacidad 32-250
- 1 Adaptador husillo Ref. B5511

10

Piezas

Ref.	CONTENIDO		
MG9572	20-22-25-32-35-38-44-60-70-76 mm	282,22 €	190,50 €

Contenido

- 1 Husillo Ref. B5519-CM ϕ 9,5 Capacidad 14-30
- 1 Husillo Ref. B5546-CM ϕ 9,5 Capacidad 32-250
- 1 Adaptador husillo Ref. B5511

7

Piezas

Ref.	CONTENIDO		
MG9573	20 - 25 - 29 - 38 - 44 - 60 - 70 mm	208,64 €	140,83 €

Contenido

- 1 Husillo Ref. B5519-CM ϕ 9,5 Capacidad 14-30
- 1 Husillo Ref. B5546-CM ϕ 9,5 Capacidad 32-250
- 1 Adaptador husillo Ref. B5511

Kit de Reparación de Insertos Libres



Insertos Libres

Kit de Reparación



D	L mm	mm	Contenido							
			3520-3.00I	3500-HIT4	3500-TB4					
M 3 x 0.50	3520-3.00K	54,43 €	36,73 €	1.50	4.50	20	3.20	3520-3.00I	3500-HIT4	3500-TB4
M 4 x 0.70	3520-4.00K	54,43 €	36,73 €	1.50	6.00	20	4.20	3520-4.00I	3500-HIT6	3500-TB6
M 5 x 0.80	3520-5.00K	54,16 €	36,55 €	1.50	7.50	20	5.20	3520-5.00I	3500-HIT8	3500-TB8
M 6 x 1.00	3520-6.00K	58,34 €	39,38 €	1.50	9.00	20	6.30	3520-6.00I	3500-HIT9	3500-TB9
M 8 x 1.25	3520-8.00K	74,17 €	50,07 €	1.50	12.00	20	8.30	3520-8.00I	3500-HIT11	3500-TB12
M 10 x 1.50	3520-10.00K	79,44 €	53,63 €	1.50	15.00	15	10.40	3520-10.00I	3500-HIT13	3500-TB13
M 12 x 1.75	3520-12.00K	91,07 €	61,47 €	1.50	18.00	10	12.50	3520-12.00I	3500-HIT15	3500-TB15
M 14 x 2.00	3520-14.00K	104,69 €	70,67 €	1.50	21.00	10	-	3520-14.00I	3500-HIT16	-

D	L mm	mm	Contenido							
M 14 x 1.25	3522-14.00K	129,74 €	87,57 €	-	3/8"	5	3522-14.00PN	3500-HIT17	-	M14x1,25



D	L mm	mm	SET M5 - M12				
M 5 x 0.80	1.50	7.50	25	5.20	3520-5.00I	3500-HIT8	3500-TB8
M 6 x 1.00	1.50	9.00	25	6.30	3520-6.00I	3500-HIT9	3500-TB9
M 8 x 1.25	1.50	12.00	25	8.30	3520-8.00I	3500-HIT11	3500-TB12
M 10 x 1.50	1.50	15.00	25	10.40	3520-10.00I	3500-HIT13	3500-TB13
M 12 x 1.75	1.50	18.00	10	12.50	3520-12.00I	3500-HIT15	3500-TB15

3520-WK1 ~~383,56 €~~ **258,90 €**

D	L mm	mm	Set Bujías		M6 - M12 + M14 X 1.25			
M 6 x 1.00	1.50	9.00	25	6.30	3520-6.00I	-	3500-HIT9	3500-TB9
M 8 x 1.25	1.50	12.00	25	8.30	3520-8.00I	-	3500-HIT11	3500-TB12
M 10 x 1.50	1.50	15.00	25	10.40	3520-10.00I	-	3500-HIT13	3500-TB13
M 12 x 1.75	1.50	18.00	10	12.50	3520-12.00I	-	3500-HIT15	3500-TB15
M 14 x 1.25	-	8.40	5	14.25	-	3522-14.00PN	3500-HIT17	-
	-	12.40	5	-	-	-	-	-
	-	16.40	5	-	-	-	-	-

3522-WK4 ~~442,00 €~~ **298,35 €**



Promoción Promoción Promoción Promoción Promoción Promoción Promoción

Brocas Fresas Afiladoras Sierras Avellanadores Sierras Oscilantes Discos Coronas Brocas Escalonadas Machos Insertos



BLUE-MASTER[®]
by *celesa*

CELESA S.A.
Polígono Industrial Arriandi
C/Tabernabari N°5
48215 IURRETA Vizcaya SPAIN
Tel +34 946232532
celesa@bluemaster.es · www.bluemaster.es

PROMOBM26
8 422798 479325

Promoción válida del 10/06/2026 hasta fin de tarifa 2026
Precios recomendados · Iva no Incluido